

CONNECT

www.bbrnetwork.com

Sixth Edition 2012

Europe's largest single pylon stay cable bridge

Timely achievement of unique
design for new Sava Bridge

First of its kind in the world

Franchised network sets
new benchmarks

The Christchurch earthquakes – the BBR Network's response

Improved damage-resistant
construction techniques

Consuming passion for LNG

Expertise in cryogenic containment
meets market demand

Electrifying performance

Strength and flexibility
to drive energy
sector projects

BBR A Global Network of Experts

www.bbrnetwork.com

The BBR Network is recognized as the leading group of specialized engineering contractors in the field of post-tensioning, stay cable and related construction engineering. The innovation and technical excellence, brought together in 1944 by its three Swiss founders – Antonio Brandestini, Max Birkenmaier and Mirko Robin Ros – continues, almost 70 years later, in that same ethos and enterprising style.

From technical headquarters in Switzerland, the BBR Network reaches out around the globe and has at its disposal some of the most talented engineers and technicians, as well as the very latest internationally approved technology.

THE GLOBAL BBR NETWORK

Within the Global BBR Network, established traditions and strong local roots are combined with the latest thinking and leading edge technology. BBR grants each local BBR Network member access to the latest technical knowledge and resources – and facilitates the exchange of information, on a broad scale and within international partnering alliances. Such global alliances and co-operations create local competitive advantages in dealing with, for example, efficient tendering, availability of specialists and specialized equipment or transfer of technical know-how.

ACTIVITIES OF THE NETWORK

All BBR Network members are well-respected within their local business communities and have built strong connections in their respective regions. They are all structured differently to suit the local market and offer a variety of construction services, in addition to the traditional core business of post-tensioning.

BBR TECHNOLOGIES

BBR technologies have been applied to a vast array of different structures – such as bridges, buildings, cryogenic LNG tanks, dams, marine structures, nuclear power stations, retaining walls, tanks, silos, towers, tunnels, wastewater treatment plants, water reservoirs and wind farms. The BBR brands and trademarks – CONA, BBRV, HiAm, DINA, SWIF, BBR E-Trace and CONNAECT – are recognized worldwide.

The BBR Network has a track record of excellence and innovative approaches – with thousands of structures built using BBR technologies. While BBR's history goes back over 65 years, the BBR Network is focused on constructing the future – with professionalism, innovation and the very latest technology.

BBR.VT International Ltd is the Technical Headquarters and Business Development Centre of the BBR Network located in Switzerland. The shareholders of BBR.VT International Ltd are: BBR Holding Ltd (Switzerland), a subsidiary of the Tectus Group (Switzerland); Spennetnikk International AS (Norway), a member of the KB Group (Norway); BBR Pretensados y Técnicas Especiales PTE, S.L. (Spain), a member of the FCC Group (Spain).





After reading the many articles and features in this edition of *CONNAECT*, you will be in no doubt that the BBR Network has 'come of age'. This unique franchise concept has brought BBR Network Members closer together and promoted many improvements, both in technology and the way in which it is deployed. This becomes particularly evident when you consider the overall green credentials of BBR technology, the scale of such projects as the elegant Sava Bridge in Belgrade, our consistently high achievement in the fields of LNG containment – and services to the energy sector in general.

The flexibility of BBR technology, combined with the expertise of the BBR Network, is realizing some commercially and technically compelling solutions. In the infrastructure sector, we are supporting the creation of practical yet exciting structures and, for buildings, we are helping to maximise usage of space – and budgets.

Our expertise across all sectors has been ably demonstrated by teams around the world – the application of BBR technology is as diverse as the people who apply it. The one constant throughout the BBR Network is the blend of engineering skills, ingenuity and innovation which is focused on each and every challenge. We look forward to supporting these endeavors over the coming year and being able to celebrate still further achievements in the next edition of *CONNAECT* magazine.

Marcel Poser
Chairman
BBR VT International Ltd

Thomas Richli
Head of Business Development
BBR VT International Ltd

Editorial, sources and references

EDITORIAL OFFICE
BBR VT International Ltd
Technical Headquarters and Business Development Centre
Switzerland
www.bbrnetwork.com
info@bbrnetwork.com

EDITOR Jane Sandy
CONTRIBUTING EDITOR Thomas Richli
DESIGNER Caroline Donner
ADMINISTRATIVE ASSISTANTS Beth Skirrow, Cecile Kopp

CONTRIBUTORS
Deirdre Allen, Enrique Arana, Tie King Bang, Kresimir Bogadi, Norbert Bogensperger, Karol Bucholc, Antonio Caballero, Yeo Swee Choo, Yan Man Chung, Sam Fassaie, Richard Gaskill, Ben Grundlehner, Karolina Haponik, Marcin Harhala, Peter Higgins, Warwick Ironmonger, Hugo Jackson, Mika Jakau, Mark Kurtovich, David Olivares Latorre, Michael Losinski, Piedad Lucas, Bartosz Lukijaniuk, George Marinos, Kew Kim Mei, Claude Neant, Damir Pavicic, Terry Palmer, Jose Luis Plaza, Mark Seisun, Keith Snow, Jacek Sowa, Lim Suan Suan, Pawel Surman, Paul Wymer, Marcin Wyrzynski, Mohd Yusri, Roland Zachar

PUBLISHER BBR VT International Ltd
NUMBER OF COPIES 10,000
Printed in England
Every effort is made to ensure that the content of this edition is accurate but the publisher accepts no responsibility for effects arising there from.
p-ISSN 1664-6606
e-ISSN 1664-6614
© BBR VT International Ltd 2012

SOURCES AND REFERENCES
Bridges section Poland's longest bridge: <http://en.wikipedia.org>
Buildings section Grand result & International showcase: <http://en.wikipedia.org>
Tanks & Silos section Consuming passion for LNG: www.reportsnreports.com, www.streamgrn.com & Hydrocarbon Asia, at www.safan.com
Expertise & easy handling: www.agrana.com & <http://en.wikipedia.org>
Stay Cables section Europe's longest stay cable bridge: www.savabridge.com
Landmark Structures section Harnessing hydro: www.engineersaustralia.org.au & www.hydro.com.au
Chasing the wind: Global Wind Report, Annual Market Update 2010, Global Wind Energy Council, at www.gwec.net & Wind in Power, 2010 European Statistics, February 2011, at www.ewea.org



2nd Coentunnel, Amsterdam, Netherlands

Immersed tube tunnel construction has become something of a tradition in the Netherlands, this feature article outlines the role played by BBR.

MAIN FEATURE: Sinking with success

69



Strong and healthy

32

Royal North Shore Hospital Redevelopment, Sydney, Australia

The benefits of post-tensioning were harnessed to provide an economically viable, strong and flexible solution for the new facilities which included a helipad.

Contents

Talking BBR

- 4 Innovatively speaking
- 6 **COVER FEATURE:**
First of its kind in the world
The BBR Network franchise is the first of its kind in the world. It was formed to harness the spirit of international networking and cooperation to deliver excellence in construction and the very highest level of customer service.
- 8 News from BBR R&D and Engineering
- 10 Coming home

Bridges

- 11 Altiani Bridge, Corsica, France
- 14 Malaga Airport South Approach, Andalucia, Spain
- 15 Entertainment City Bridges, Lusail, Qatar
- 16 Infrastructure projects, Poland
- 18 Waipuna Bridge, Auckland, New Zealand
- 19 Belconnen Way Overbridge, Canberra, Australia
- 22 AI Motorway Bridge, Grudziadz, Poland
- 23 Seitenhafenbrücke, Vienna, Austria
- 24 Pisuerga River Bridge, Valladolid, Spain

- 26 Sungai Teru Crossing, Miri, Sarawak, Malaysia
- 27 Odra Viaduct, Zagreb, Croatia
- 27 Traunbrücke, AI Motorway, Steyermühl, Austria
- 28 **MAIN FEATURE:**
Spanning urban green



Featuring a spectacular white concrete bowstring arch, the new Las Llamas Bridge, across a city centre park, provides a much needed connection between two key areas of Santander, Spain.

- 30 RI Motorway Bridge, Nitra, Slovenia
- 31 Ribnica Bridge, Podgorica, Montenegro
- 31 AI Motorway, Upper Silesia, Poland

Buildings

- 32 Royal North Shore Hospital Redevelopment, Sydney, Australia
- 34 Opera house rehearsal stage, Vienna, Austria
- 35 Arena Center, Zagreb, Croatia

- 36 Parking structures, Malaysia, Poland and New Zealand
- 37 K-Mart distribution warehouse, Auckland, New Zealand
- 38 Dee Why Grand, Sydney, Australia
- 39 Essex Magistrates' Courts, Essex, UK
- 40 ADNOC Headquarters, Abu Dhabi, United Arab Emirates
- 41 School of the Arts, Singapore
- 42 Office buildings, Warsaw & Szczecin, Poland
- 43 Asia Square, Marina Bay, Singapore
- 43 Plaza 33, Petaling Jaya, Malaysia
- 44 ExCeL Exhibition Centre, London, UK
- 45 BIW Hotel, Bahrain, United Arab Emirates
- 46 University buildings, UK & Australia
- 48 Railway Viaduct, Wroclaw, Poland

Tanks & Silos

- 50 Consuming passion for LNG
- 52 LNG tanks, Gijon, Spain
- 54 Sugar silo, Tulln, Austria
- 56 4th NGL Train project, Abu Dhabi, United Arab Emirates

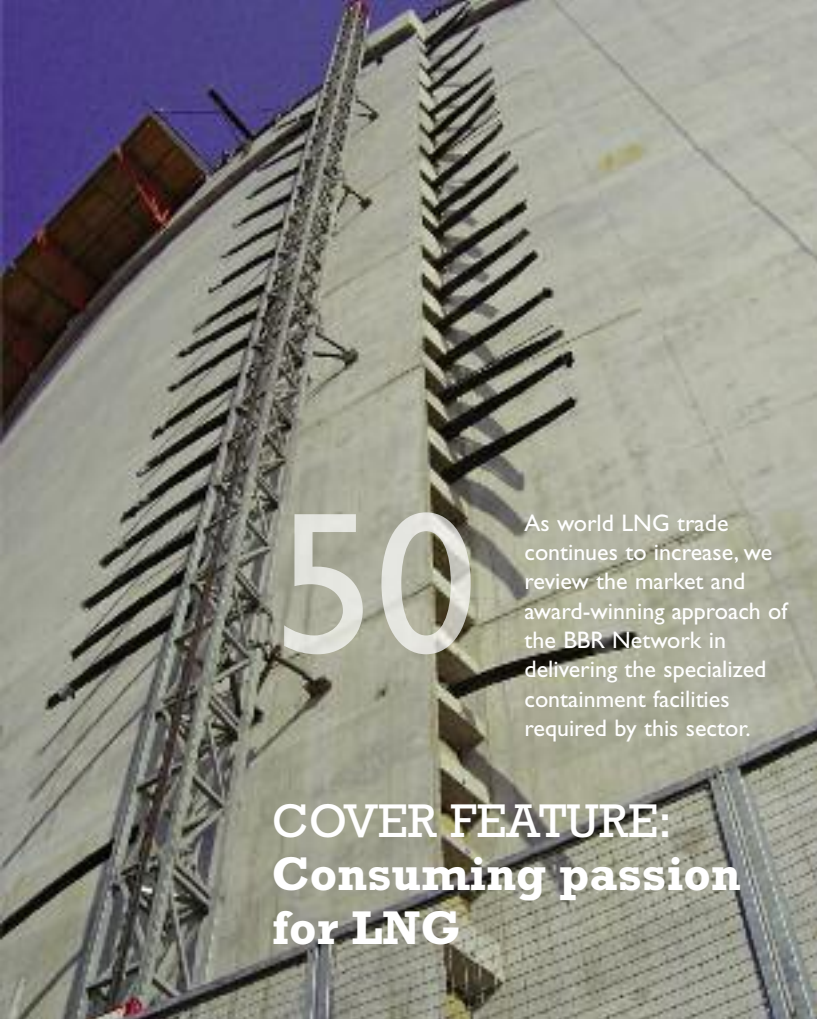

50

As world LNG trade continues to increase, we review the market and award-winning approach of the BBR Network in delivering the specialized containment facilities required by this sector.

**COVER FEATURE:
Consuming passion
for LNG**



Historic landmark

We look at how earlier BBR projects fared in the city of Christchurch and offer insights on lessons learnt and new seismic technologies.



**79
COVER FEATURE:
The Christchurch earthquakes**

Stay Cables

**57 COVER FEATURE:
Europe's largest single pylon stay cable bridge**



The dramatic new Sava Bridge has become a major landmark for the city of Belgrade, Serbia. BBR Stay Cable technology was effectively and efficiently installed to meet a greatly shortened program. Reflections on its construction and stay cable bridge engineering design are provided by Dipl.-Ing. Holger Svensson of Leonhardt Andrä & Partner.

- 62 River Minho Bridge, Lugo, Spain
- 63 Stay cable footbridge, Witrylow, Poland
- 64 Basarab Flyover Bypass, Bucharest, Romania
- 67 Pedestrian bridge, Blackburn, South Africa
- 68 Otopeni Bridge, Bucharest, Romania

Special Applications

- 69 2nd Coentunnel, Amsterdam, Netherlands
- 72 Sungai Siol Bridge, Matang, Sarawak, Malaysia
- 72 River Danube Bridge, Vidin-Calafat, Bulgaria & Romania
- 74 Wellington Dam, Collie, Western Australia
- 76 Reinforced soil structures, Poland
- 77 Prill Tower, Moranbah, Queensland, Australia
- 78 Al-Wehdah Dam, Irbid, Jordan
- 78 Triathlon VIP Zone, London, UK

MRR

- 79 The Christchurch earthquakes – the BBR Network's response
- 85 Semedela Overpass, Koper, Slovenia
- 86 Queens Wharf, Auckland, New Zealand

Landmark Structures

- 87 COVER FEATURE:
Eletrifying performance**
From the massive heavy engineering feats for hydroelectric dam strengthening to the high-tech, high safety environment of nuclear installations and onto the elegance of wind towers, BBR technology shows that it has the strength and flexibility to meet the very different challenges set by today's energy sector.



- 94 BBR Worldwide Directory

Innovatively speaking

Since its foundation almost 70 years ago, innovation has been at the very heart of BBR and continues to provide the driving force for technological and commercial advances. Thomas Richli, Head of Business Development of BBR VT International Ltd, explores the nature of innovation and its role within today's market place.

WHY CHOOSE INNOVATION AS A THEME?

Simply because absolutely everything we do is about innovation. This first became clear to me while making visits to franchisees and construction sites – and indeed our franchisees' customers – around the world. Each construction project is unique – there's no such thing as a standard product in terms of a structure. It has to be that way to meet the specific needs of customers and end-users. Actually, we are innovating every time we start a new project – by using different engineering techniques and technology combinations. In fact, when you look through *CONNAECT*, you'll see examples of engineering innovation everywhere – both now and in our past.

Then I thought a bit more about the BBR Network as a whole – we describe it as a new kind of franchise. Well, in terms of a business model, that's actually innovation too – usually, the franchise concept is applied to the consumer goods market rather than to sophisticated construction engineering and services businesses.

OK, I guess being Swiss helps us to embrace innovation as well – it's somehow in our national psyche to continuously seek improvement. This is especially good news when you also consider that the media are reporting that, due to the strength of the Swiss Franc, it's now imperative that Swiss-based companies should innovate even more. According to the Global Innovation Index, Switzerland is already at the top of the innovation league table. So, lots of creativity and lateral thinking is going on here!

HOW DO YOU DEFINE 'INNOVATION'?

In simple terms, it's the ability to take something we already have or do and make



it better, so that it's more suitable for the way we live and work. If you look into history, you'll see that the human race has progressively improved all sorts of products and processes over the years. The BBR story is actually a good reflection of this – progressive improvement of our technology and 'go-to-market' strategy has ensured not only our continuous success, but also that the construction industry has access to the very latest technology and engineering. Take prestressing, for example. It's been around for more than a century, having evolved from the shipbuilding industry – but it's how you improve it that counts. That's what we do – improve and renew.

... BUT ISN'T THIS JUST 'RE-INVENTING THE WHEEL'?

Exactly, that's my whole point! Innovation shouldn't be confused with invention – innovation isn't about inventing anything new, rather just improving what already exists. When there's already an established demand for the product or service, with market feedback and expert observation, it is often desirable or necessary to enhance the offering or approach. At BBR, we've been listening to customer feedback for years and our latest response has been to develop a new range of improved technology. And we will never stop listening to what the market tells us, it's our reason for existing.

WHERE DO IDEAS COME FROM TODAY?

There are so many drivers for innovation – the list is almost endless. I guess the most important impetus, in our industry comes from an end-user perspective. Our customers have specific needs or wishes and these drive innovation – they're a key source. With post-tensioning, you can make so many amazing structures – large column-free spaces in buildings and long spans for bridges – all that's needed is our expertise and imagination in applying it.

For us from the BBR HQ, other catalysts include feedback from our franchisees – with some 2,000 enquiries a year, we need to make sure we take on board the lessons learnt from these and do things a bit differently to align ourselves better with what the market wants. We also work closely with universities and these dialogues are always food for thought – and often inspire future improvements. Industry conferences and our active role in technical commissions frequently generate issues for us to follow up on too. Of course, we're always watching our competitors as well – we look at what they do and strive to improve upon their approach. What's happening in other industries influences our business too. There's input from almost everywhere you look!

Then you have government policies, like the need for a European Technical Approval (ETA), as well as requirements of industry associations such as *fib* and PTI. Right now, it's pretty clear that the innovation barometer has moved towards protecting our macro-environment – the planet. Governments around the world are encouraging sustainable practices both by legislation and by initiating important dialogues – essentially creating a framework for innovation in green technology and practices.

While BBR technology and techniques have, by their very nature, always promoted a sustainable approach, we continue to seek further opportunities to refine and enhance their green credentials.

HOW DO YOU REMAIN COMPETITIVE?

You know, if you look at the requirements of a franchising system, as a franchisor you are obliged to be innovative – it is strongly recommended that you listen to your franchisees. You cannot develop a system, product or strategy – and then not touch it for ten years. This forces us to continuously improve our service and products.

End-user benefits are that they get the latest proven technology, delivered through a locally customised service. Usually, you have a tool or a product and give someone the licence to use it. With the BBR franchise, there is more – franchisees benefit from latest approved technology, know-how, strong brands, quality and procurement management and regular training sessions as well.

The BBR franchising model clearly works – there's been a significant annual growth over the last couple of years. Even last year, we set a new record for growth.

GIVE US SOME EXAMPLES OF BBR INNOVATION?

Recently there have been two excellent examples of BBR innovation – BBR E-Trace and the BBR HiEx CONA Saddle. These are typical of the type of innovation we've developed and rolled out successfully. Originally, BBR E-Trace grew out of a requirement, under ETA, for Factory Production Control – which would have prompted a massive increase in paperwork. So we thought about developing a platform to do this – while also fulfilling procurement

needs and creating an interface for exchanging information, beyond just ordering products and documenting quality. Some years ago, franchisees were being asked to provide an extradosed system. It was natural that we should look at what we could do to offer a saddle solution. We already had a European Approved system, so were able to use part of this and also the HiAm CONA system. With proven technology for the stays and pylon, all we had to do was to connect these two technologies – and test our solution to ensure the two technologies worked together.

WHAT CAN WE EXPECT FROM BBR IN THE FUTURE?

Ah ... now that would be telling! As you would expect, our program of testing improved technology continues and we will be making announcements about this later. Meanwhile, we are continuing to review all the requirements and ideas we get from site visits, training courses and conferences. An idea isn't something you can immediately use to create competitive advantage or improve your business model. So, having gathered the information, we explore what we can do to turn it into a product or a service ultimately benefiting end-users and customers. Over coming months, we will be looking at our franchising system and improving our role, both as a Network and as a franchisor. Our goal is to continue to grow, so you can be certain of reading about future innovation in subsequent editions of *CONNAECT*. ●





GLOBAL BBR NETWORK FRANCHISE

First of its kind in the world



The BBR Network franchise – the largest and first of its kind in the world – evolved from the licensed business which had traded successfully on the international scene since the 1940s, and has grown in recent years both in terms of geographical coverage and business volume – and is now truly greater than the sum of its parts.

Bureau BBR, as the company was first known, was born of wartime material shortages – and engineering innovation at its very best. The three founders – Max Birkenmaier, Antonio Brandestini and Mirko Robin Ros – explored the savings to be made by using pretensioned reinforcement for concrete support girders. From there, they ventured further – into the development of a complete range of prestressing and post-tensioning systems, ground anchors and stay cable anchorages, covering all structural engineering applications.

BUILDING THE TEAM

Over the years, the successful development of BBR continued, with many landmark projects featuring in our portfolio, however, this was not enough – our vision was far greater than this.

We wanted to create even closer ties with the companies and people who were using BBR technology in their local markets. It was important that this was achieved in a way that the wealth of expertise could be shared with people in other parts of the world and, in turn, be fed back to the Swiss HQ and fuel subsequent improvements in both technology and service.

By creating a franchised group – the Global BBR Network of Experts – we were able to formalize relationships between the BBR

What is a franchise?

The McDonalds fast food business is widely regarded as being one of the world's earliest and most successful franchise. The BBR Network franchise is broadly similar, with several key differences, which make it one of a kind.

FRANCHISE – created when a 'franchisor' allows use of his brand or trademarks, know-how and processes, by a 'franchisee'. Thus franchisees can use a proven concept to further develop their own businesses and the franchisor can extend the geographic and market reach of his business. In the BBR Network franchise, much more than brands and trademarks are included – for example, access to approved technology, latest system applications, certification, training and marketing communications support.

FRANCHISE AGREEMENT – provides the franchisee with the terms under which he is permitted to operate the business. The BBR franchise agreement includes both the franchisor's and franchisee's obligations using the franchised system applications for a fixed period of time, and allows for renewal.

FRANCHISOR – typical responsibilities include system development, continuing product support, marketing campaigns and supply chain management. He will want to monitor franchisee performance. BBR VT International as the franchisor commits to continuously improve the technology, QA, supply chain and know-how transfer:

FRANCHISEE – will agree to follow the rules set out by the franchise agreement and to take an active role in furthering the franchised technology and business aims. Normally, franchisees will pay a start-up fee, followed by annual 'management service fees' or royalties. A BBR franchisee is fully qualified to source, assembly and install the system applications to the highest service and quality standards.



head office team and a loyal band of international construction engineering specialist companies. The structure and commitment flowing from this process has benefitted – and will continue to benefit – not just the BBR family, but also the construction industry as a whole.



GROWING STRENGTH

Over recent years, we have focused heavily on developing new technology, strengthening of the Network, and creating of a range of marketing communications material. Indeed, we have invested many millions of Swiss Francs to produce the most up-to-date and approved systems.

The BBR Network also draws strength from the continuously growing sense of 'family' felt among Members. They like attending conferences and training sessions because of the potential for exchanging information with BBR HQ and other franchisees.

Training seminars on technology – and specialized subjects, like stay cable seminars for instance – are the mainstay of the way in which knowledge is passed from BBR HQ to the BBR Network. In 2011, nearly 100 delegates came to the BBR regional training



Advantages of the BBR Network franchise system

- ▶ Latest internationally approved PT and stay cable technology
- ▶ Professional marketing and communication tools
- ▶ Technical, commercial and project specific support
- ▶ Leading edge supply chain and quality management systems
- ▶ Regular regional and local training seminars
- ▶ Knowledge transfer; global and regional forums and conferences
- ▶ International collaborations and alliances for large or special projects
- ▶ Recognized global brands and trademarks
- ▶ Proven franchise system, backed by a continuously advanced technology for over 65 years
- ▶ Strong local roots and highly qualified professionals for highest customer service backed by a global enterprise – the BBR Network



seminars – and a few dozen more attended sessions held locally, at the franchisees' offices.

The creation of the BBR Factory Production Control and BBR E-Trace has revolutionized the way in which BBR technology is manufactured, procured and distributed to the highest quality standards, while offering whole life traceability. It is being further developed to become an 'exchange database' so Members will be able to see who is doing what.

SETTING NEW BENCHMARKS

At BBR HQ, we do realize that many developments have been introduced at what may seem like lightning speed to some people in the construction industry. Therefore, our emphasis will be on creating a deeper understanding of the wide range of possibilities open to BBR Network Members. So, now we will be further investing in training, sharing resources and networking.

Without doubt, before we are celebrating the first decade of the BBR Network, we will see an even greater number of joint ventures between Members to realize some of the world's largest and most challenging projects. We will also see a market place which, with the help of the BBR Network, fully appreciates the complete spectrum of offerings – in terms of BBR technologies, know-how and customized service for our clients – that we can provide.



Latest BBR technology

BBR VT International's Research & Development (R&D) and Engineering team, led by Dr. Antonio Caballero, is continuously reviewing, testing and developing ways to refine and enhance BBR technology, ensuring that the BBR Network always has access to the latest and best construction technology.

Recent developments include the innovative BBR HiEx CONA Saddle which is already being used for two major bridges and, in addition, we have secured European Approvals for our CONA CMF and CONA CMM Single post-tensioning technology.

STAY CABLE CONNECTIONS

Stay cables are connected to the pylon using standard anchorages or saddles. Saddles offer designers various advantageous options – such as a better arrangement of cables at the pylon and reduced pylon dimensions. However, standard saddles, either friction or shear key, exhibit some significant drawbacks, which discourage their use:

- ▶ Load carrying elements cannot be inspected or replaced
- ▶ Slippage when faced with moderate differential forces
- ▶ Fretting fatigue
- ▶ Strand installation and removal/replacement is either limited or impossible

“ THE BBR HIEX CONA SADDLE IS THE LATEST SADDLE APPROACH FOR CABLE-STAYED AND EXTRADOSED BRIDGES ”

BBR HIEX CONA SADDLE

The BBR HiEx CONA Saddle is the latest saddle approach for cable-stayed and extradosed bridges which completely eliminates the problems associated with standard friction saddles. This modern saddle concept replaces the standard friction saddle or shear key with a post-tensioning saddle, thus creating a compressive concrete environment and providing a fixed point for the stay cable at the pylon.



MONOTUBE APPROACH

The standard configuration for the BBR HiEx CONA Saddle consists of a parallel arrangement of individual guiding systems surrounded by a high strength grout – all enclosed in a curved smooth steel pipe. Seven-wire HDPE-sheathed prestressing steel strands – factory provided with corrosion protection filling material – are inserted through the guiding system and connect coupler heads placed at both sides of the pylon. While the high strength grout provides a stiff environment, strands are fully replaceable as there is no bonded connection between the guiding system and external HDPE of the strands. The minimum radius of this saddle configuration is up to 2.0 m.

FULL BUNDLE APPROACH

Alternatively, a bundle of bare strands fully bonded to the pylon might also be used, if permitted at the place of use. The minimum radius of this saddle configuration depends on the degree of filling and maximum contact pressure permitted at the place of use.

Benefits of BBR HiEx CONA Saddles

- ▶ The stay cable technology, used on left and right stay cables, is proven and tested according to *fib* and other recommendations.
- ▶ The saddle is equipped with tested and European approved post-tensioning technology.
- ▶ The entire differential force is fully transferred without saddle slippage.
- ▶ Post-tensioning force at the saddle is higher than maximum service load at the stay cable, which eliminates axial fatigue and fretting fatigue on the saddle.
- ▶ The compressive environment prevents tension cracks and enhances corrosion protection.
- ▶ Inspection, replacement and strand-by-strand cable installation are all possible.



- ▶ Corrosion protection is greater than in conventional saddles with up to five corrosion barriers in the standard configuration.
- ▶ During maintenance/replacement operations, only replacement of the affected stay cable on one side of the pylon is required – and not the full length. Replacement is even easier because tensile elements, which need to be removed, do not cross the pylon.



STAY CABLE AND SADDLE CONNECTION

The BBR HiEx CONA Saddle and BBR HiAm CONA stay cable are connected through a coupler sleeve, the BBR HiEx CONA Sleeve-W. Both the post-tensioning coupler head of the PT saddle and the nut head of the stay cable are threaded into the sleeve coupler. The CONA Sleeve-W incorporates two lateral windows to allow wedge inspection, strand-by-strand installation and cable replacement.

SADDLE FATIGUE TESTING

The HiEx CONA Saddle has been tested for both ultimate axial transfer loading and fatigue with subsequent loading. Fatigue testing was carried out to an axial stress-range of 200 MPa for 2,000,000 load cycles with anchorage rotations of 0.6° at an upper

axial load of 55% GUTS, which covered both *fib* and CIP specifications for stay cable and extradosed applications. After fatigue testing, the BBR HiEx CONA Saddle was axially loaded to 100% GUTS, while state-of-the-art recommendations only require 95% GUTS.

NEW INTRODUCTIONS

BBR VT International has introduced two new European approved post-tensioning kits for special flat slab applications.

CONA CMF FLAT SYSTEM

The new BBR VT CONA CMF BT contains the latest post-tensioning technology for flat slabs requiring PT tendons with 02 to 04

strands. The new system is based on 0.5" (93 mm² and 100 mm²) and 0.6" (140 mm² and 150 mm²) standard prestressing strand or monostrand. The new flat bearing trumplate has an optimal rectangular outer shape, which allows it to be installed in the thinnest slabs. Three different planes, whose slenderness has been designed to reduce the peak of the bursting stresses, transfer the load to the concrete and allow for full stressing at very low concrete strength. The anchor head is in a separated body and common to the CONA CMI family, bringing reliability and competitiveness to the system. The CONA CMF system has been tested against static load, fatigue load and load transfer to the structure. The system fully complies with the Technical Approval Guideline ETAG 013.

CONA CMM SINGLE

The CONA CMM family, exclusive for unbonded tendons, has recently been extended with the CONA CMM Single for bonded applications. The new post-tensioning system is now also available with single 0.6" (140 mm² and 150 mm²) standard prestressing strand for bonded applications. The system can be used in combination with round corrugated steel or plastic ducts. The new development has also required some grouting tests which have shown very satisfactory results in all critical locations, such as the wedge area and couplers. ●

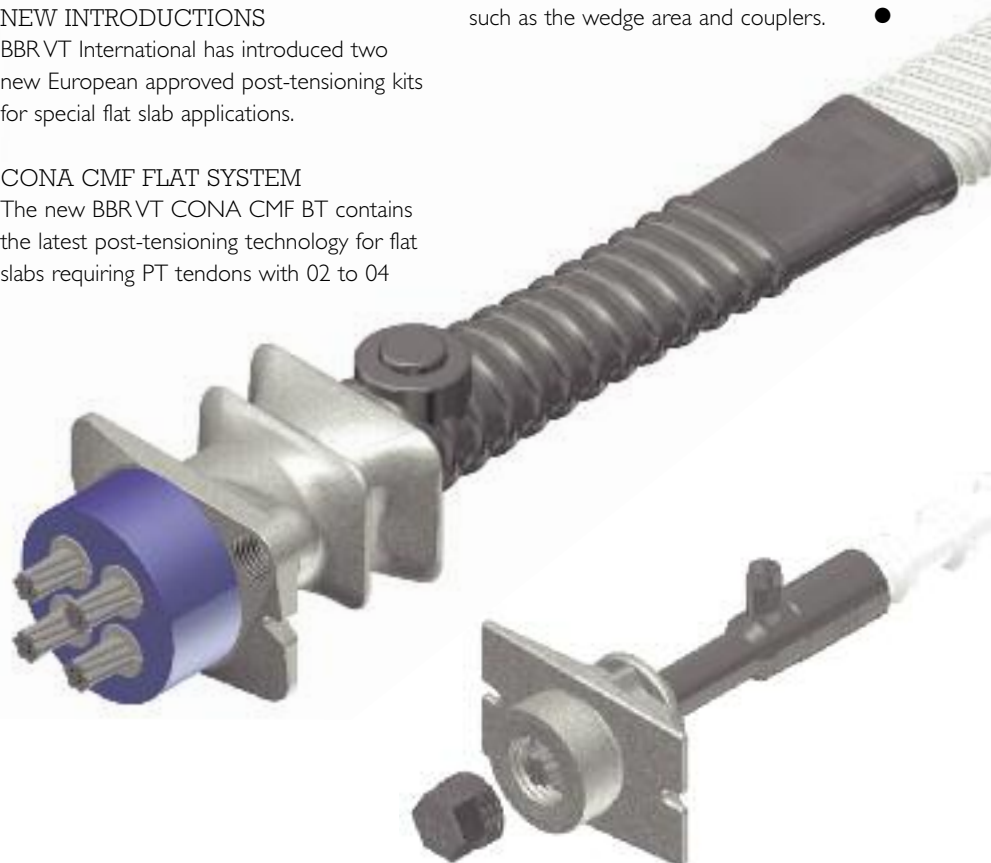

Coming home



In May 2011, the annual BBR Global Conference came home to Switzerland – the country of its birth. Delegates from every corner of the globe converged on beautiful Lucerne to learn, share – and enjoy!

DISCUSSION FORUMS

As well as many opportunities to raise questions and topical issues throughout the conference, a marketing and production forum and the closing technical discussion gave delegates the chance to both seek support in specific areas and offer their input into future initiatives.

GLOBAL BBR CONFERENCE 2012

Our next conference will be held on Bintan Island, Singapore in early March. ●

This three day event began in traditional style with a Charity Golf Day which raised CHF4,000 for the Kantha Bopha charitable children's hospital foundation in Cambodia. In the evening, delegates took a boat trip on Lake Lucerne to catch their breath and exchange news together. The next day, Marcel Poser gave an opening address marking the start of the formal part of the conference.

SHARING INTERNATIONAL KNOW-HOW

Delegates had the opportunity to hear first hand about the construction of the iconic Kuala Trengganu footbridge from Yok-Lin Voon of BBR Construction Systems Malaysia and about external prestressing in Poland from BBR Polska's Jacek Sowa.

SPECIAL GUEST

Our guest presenter this time was Luis Cancio, J L Cancio Martins Structural Engineers who shared his experiences on the subject of 'PT bridge design with BBR technology'.

BBR TECHNOLOGY

A review of the state-of-the-art BBR VT CONA CMX post-tensioning technology was presented jointly by Antonio Caballero and Mathias Gallati. Later, Antonio also gave a presentation entitled 'BBR HiAm CONA – superior stay cable technology'.

WORK WINNING

Thomas Richli led sessions on efficient procurement within the BBR Network and bridge construction networking. Meanwhile,

delegates heard about latest developments and plans for BBR E-Trace and the new corporate BBR website from Piotr Krawczonek & Chris Roost and Valentina Mihajlovic & Daniel Senn respectively.

BBR Project of the Year 2011

This time around, there were a huge number of projects which

demonstrated the excellence of BBR technology and the Network. However, two projects in particular captured the attention of the judging panel, so a joint award was made this year to BBR Polska –

for the Krakow Footbridge and Warsaw's Temple of Divine Providence.

Although very different in nature, the complexity of the construction involved in both of these projects – and the highly competent way in which BBR Polska rose to meet the challenges – demanded recognition.

Through these two projects, the consistent achievement of high technical standards within the BBR Network can be appreciated by construction customers around the globe.

Other award winners included Structural Systems Africa for Best CONNAECT Article for *Building launch bridges* in Southern Africa – their engaging article placed the project well in its local context and conveyed the technical expertise and spirit with which it was completed. Spanish BBR Network Member, BBR PTE, won the prize for Best CONNAECT Photography for the material illustrating *Vital link*, their article about the River Ebro Bridge project in Tarragona, Spain. Finally, a special Innovation Award was presented to Structural Systems who, as well as taking on some of the world's most technically complex and challenging projects, are consistently 'early adopters' of new BBR systems and techniques.



ALTIANI BRIDGE, CORSICA, FRANCE

Historic LANDMARK



Just a few meters away from Corsica's famous medieval Louis XVI style bridge, built during the Genoan occupation of the Mediterranean island, a dramatic new bridge is now set to take its own place in history over the River Tavignano. Claude Neant of French BBR Network Member, **ETIC**, provides an overview of his company's role in the creation of this new landmark. →



The new Altiani Bridge lies between the towns of Aleria and Corte and spans the River Tavignano, in northern Corsica. The architecture of the historic bridge influenced the architects for the new bridge, Lavigne et Cheron and the renowned structural engineer Michel Virlogeux, in collaboration with SECOA, all of whom also visualized an arch bridge, but with a few modern alternatives – such as post-tensioning in the slab. The 12 m wide deck slab is very thin – it is just 60 cm thick, increasing to 80 cm where the arch joins the slab. There are two lateral spans – of 15 m and 17 m long – either side of the 56 m long centre span which connects with the central arch. The arch is designed with a cross-section of 2.4 m by 0.5 m above the foundation and this divides into two parts just before the connection with the bridge slab.

This structure was erected over the river in phases and was concreted in-situ using a variety of formwork and scaffolding. As the River Tavignano can sometimes be very dangerous, construction was programmed to take place between spring and winter; when the water level in the river is low.

ALTERNATIVE SOLUTION

ETIC proposed an alternative solution for the arch bearing. Each bearing in the original design – comprising one steel linear articulation joint – has been exchanged for four pot bearings installed side-by-side between two plates. This way, if necessary, the bearings can be replaced as part of any future maintenance operations.

PT PROCEDURES

The post-tensioning was designed in accordance with the various construction stages.

After concreting the two lateral spans between the first abutments and the second piers on either side, we stressed the first group of eight BBRVT CONA CMI 1206 tendons which were to be coupled for the next phases. The remaining 12 tendons awaited final stressing. Next, the first half of the arch – from the left bank to where it joins the slab – was erected with BBRVT CONA CMM 0406 tendons. After this, the other half of the arch was constructed. Five special jacks were then installed, on temporary steel supports, between the two sections of the arch and on top, connecting with the bridge slab.

SPECIAL FORMWORK

When the load had been transferred to the five jacks, we set out the special formwork for the arch. After checking the arch displacement and the corresponding pressure, the jacks were fixed down. Next, we installed the formwork for concreting the two lateral spans of the arch and placed the tendons for these.

After concreting the two lateral spans, we prepared the CONA CMM 0406 tendons on the top of the arch to assure their continuity before concreting the corresponding part of the slab and arch.

We then performed a horizontal load lifting operation with the five jacks on the top of the arch and we placed the formwork support. In this operation, the two parts of the arch had to be displaced by approximately 30 mm.

The arch was held in this position and the space between the two extremities of the arch were connected with the slab, then after installation of special formwork, it was concreted. For this concreting operation, the five jacks were installed on a special recess.

The load on the jacks was released by cutting the temporary steel support installed below the jack and the recess was concreted. We then stressed the first phase CONA CMI 1206 tendons in the slab with couplers at each end for continuity.

The formwork on the lateral span of the arch was released and stressing of the CONA 0406 CMM tendons in the arch took place. Finally, we carried out the installation, tensioning and grout injection of the last tendons – which were 116 m long – for continuity of the deck slab.

CONNECTING CHALLENGES

The main challenge for us was the connection between the post-tensioned arch and the longitudinally post-tensioned thin slab – the latter being only 60 cm thick.

The stage where load was transferred using jacks – including the



Facts & Figures

BRIDGE DECK SLAB:

20 × BBR VT CONA CMI 1206
cement grouted tendons

115 m long

33 t prestressing steel

2 × 20 anchors

2 × 8 couplers

CENTRAL BRIDGE SPAN ARCH:

2 × 18 BBR VT CONA CMM
unbonded 0406 tendons

33.25 m long

6 t prestressing steel

SPECIAL POT BEARING FOR ARCH BRIDGE:

4 × fixed 3,000 kN pot bearings for
each foot of arch to reduce width in
accordance with arch section

installation of scaffolding formwork and concreting of the corresponding joint where the arch and slab connect – was also one of the main issues of the original design. The original design made it necessary to release the jacks without any chance of increasing the first calculated pressure, due to the concreting of this gap with reinforcement bars.



“ THE MAIN CHALLENGE FOR US WAS THE CONNECTION BETWEEN THE POST-TENSIONED ARCH AND THE LONGITUDINALLY POST-TENSIONED THIN SLAB – THE LATTER BEING ONLY 60 CM THICK. ”

However, our alternative solution made an effective load transfer achievable – by installing temporary steel support between the jacks and the arch section. With our alternative method, the transfer of load was not only possible, but also made very easy – we simply had to cut the special temporary support which had been designed and

fabricated from very thin steel plate. This was a technically demanding task in any circumstances, however; we should also mention the dangers presented by the small river – the Tavignano – which was subject to flash flooding. The river levels in this area of Corsica can rise very high very quickly because of rainfall or melting snow, risking the uplift and collapse of the arch under construction before it had been concreted together with the deck slab. As with many construction projects, timing – and good planning – is everything! ●

TEAM & TECHNOLOGY

OWNER Collectivité Territoriale de Corse (CTC)

MAIN CONTRACTOR

JV – CARI, TERRACO & ETIC

ARCHITECT Lavigne et Chiron

DESIGNER Michel Virlogeux, SECOA

CONSTRUCTION DESIGN COGECI

TECHNOLOGY BBR VT CONA CMI internal

BBR VT CONA CMM monostrand

Special pot bearing

Expansion joint

BBR NETWORK MEMBER ETIC S.A. (France)

Gateway to the sun

MALAGA AIRPORT SOUTH APPROACH, ANDALUCIA, SPAIN



From Malaga on the Costa del Sol – the land of beaches and sun, a favorite tourist destination in Andalusia – Piedad Lucas of **BBR PTE** reports on an ambitious project. Malaga Airport is to have an independent and important new access, allowing tourists from around the world to travel easily into one of Spain's most friendly and comfortable regions to live.

In just a few years, the number of people using Malaga Airport had nearly tripled and the increased traffic led to the extension and complete refitting of the airport. Meanwhile, on the outskirts of the airport, there is a large continuously developing industrial centre and an urban area which is also experiencing significant expansion.

DIRECT ACCESS

These circumstances made it imperative that the Ministerio de Fomento launched this

project to support the airport with an important new direct access. Thus, the 'Acceso Sur al Aeropuerto de Malaga' scheme was born.

The need to avoid interference with surrounding airport areas or existing infrastructure dictated that the new access route should be an elevated structure of considerable length – with connections at three levels, formed by four branches connecting to the A7 – Mediterranean Highway.

WIDE IN-SITU DECK

The new structure is almost 2,500 m long and has the widest in-situ concrete deck constructed in Spain by FCC. The standard span between pillars is 40 m, expanding to reach 47 m at some points. Given the length of the deck, joints were installed at every 160 m – four spans – at one fifth of the span, the point where bending moments are almost zero. The transversal section has an 11.5 m wide and 1.6 m high cast in-situ post-tensioned slab.

ONE MILLION KILOS PT STEEL

For this structure the post-tensioning is the key player. Up to 12 tendons with 3106 strands were installed during various phases, which brings the total amount of steel used to more than a million kilograms

“ FOR THIS STRUCTURE THE POST-TENSIONING IS THE KEY PLAYER. ”



– and we used over 900 CONA CMI anchorages and couplers. Post-tensioning has also been used to solve specific issues on this project – for example, transverse beams and the linking of four prefabricated beams to pillars with cast in-situ spans. One of the major challenges on this project has been making the connections to existing roads with only minimal interruptions to their heavy traffic flows. ●

.....
TEAM & TECHNOLOGY

OWNER Direccion General de Carreteras (Ministerio de Fomento)
MAIN CONTRACTOR FCC Construccion S.A.
DESIGNER INECO
TECHNOLOGY BBR VT CONA CMI internal
BBR NETWORK MEMBER BBR PTE, S.L. (Spain)
.....



BRIDGES

ENTERTAINMENT CITY BRIDGES, LUSAIL, QATAR

Five bridges in Qatar

BBR Network Member NASA Structural Systems was appointed to provide specialist post-tensioning services for three road bridges and two footbridges in Entertainment City by Hamad Bin Khalid Contracting Co.WLL who are responsible for developing primary roads and utilities infrastructure required for the new city.

Entertainment City, being developed by Abu Dhabi Investment House, is part of the Lusail Development which is located along the sea shore on the outskirts of Qatar's capital city of Doha. Lusail City is expected to have 200,000 residents and host the opening ceremony, group matches and final game of the month-long FIFA 2022 Football World Cup tournament at its 86,250-seat Lusail Iconic Stadium.

The five bridges were required to span over the network of man-made canals. The road bridges were comprised of in-situ post-tensioned 'T' girders of lengths from 22 m to 25 m with in-situ reinforced concrete deck

slabs, while the pedestrian bridges were comprised of twin cell cast in-situ box girders of 25 m and 40 m lengths. We proposed and successfully implemented solutions using BBR VT CONA CMI 1205 and 1905 anchorage systems for all road bridges and BBR VT CONA CMI 1206 to 1906 anchorage systems for the pedestrian bridges. Despite a significant track record, including numerous post-tensioned building projects in Qatar, this project was very special to us as it was NASA Structural Systems' first bridge project in Qatar. ●

.....
TEAM & TECHNOLOGY

OWNER Entertainment City Qatar (Abu Dhabi Investment House)
MAIN CONTRACTOR Hamad Bin Khalid Contracting Co.WLL
DESIGNER Associated Consulting Engineers
TECHNOLOGY BBR VT CONA CMI internal
BBR NETWORK MEMBER NASA Structural Systems LLC (United Arab Emirates)
.....



CLEARING THE BACKLOG

INFRASTRUCTURE PROJECTS,
POLAND



After many years of backlog in the construction of Polish road and bridge infrastructure – a legacy of the former communist system – clearing it is a current day necessity. Rapid infrastructure development is still taking place in Poland, thanks to loans from the European Union. **BBR Polska** now features in its portfolio a wide range of recent infrastructure projects, both large and small. Site Manager, Karol Bucholc who specializes in this field, has actively participated, together with his colleague Marcin Wyrzynski, in all of the projects and from an early stage.

1 POZNAN WESTERN BYPASS

The bypass around the western city of Poznan was constructed as part of the S11 express road dual carriageway – linking Poznan to Koszalin, as well as the S5 express road, connecting Poznan and Wroclaw. The task was divided into several stages. The first stage was the 14.2 km long Zlotkowo-A2 (Gluchowo) section which consisted of 14 viaducts, one bridge and two bicycle/pedestrian paths. This major project comprised the construction of several structures including seven post-tensioned flyovers, the launching of steel arches and the assembly of bearings and expansion joints, as well as the prestressing of one overpass.

2 WARSAW SOUTHERN BYPASS S2 EXPRESSWAY

The Warsaw Southern Bypass project is the S2 express way from Konotopa junction to Pulawska junction, together with the expressway S79-NS route section, linking the Airport junction to both MPL Okęcie and Marynarska junctions. It includes 13 flyovers, two footbridges, a tunnel and 18 km of noise barriers. This route extends to approximately 10 km outside of Warsaw city centre.

We were commissioned for the prestressing of the large flyover – a complex construction, in a horizontal and vertical arc, with internal and external cables. We were also contracted

for the design and construction of reinforced soil walls with wall panels. In addition to this, we are to supply and install expansion joints for many of the other structures, as well as PT bars on a suspended pedestrian walkway.

3 A2 MOTORWAY BYPASS – MINSK MAZOWIECKI

The Minsk Mazowiecki section of the A2 Motorway Bypass is part of the E-30 road – one of the East-West Trans-European routes which is a direct continuation of this route beyond Warsaw. It is the first section to be completed east of the River Vistula. Some time ago, we built two post-tensioned



structures on this stretch of road and, in 2010 we received another contract as the project was almost completed. It was for two prestressed single-span structures forming a motorway viaduct with a span of about 40 m. We stressed the first structure in summer 2011 and completed the second one just before the onset of winter. Completion of the entire route is scheduled for August 2012.

4 NORTH BRIDGE ROUTE

North Bridge Route is a 3.4 km long section of highway with a river bridge which, together with access roads, is the main structure of the North Bridge over the River Vistula. Within the scheme, we have been commissioned to prestress three structures, including a large flyover within Modlinska Street. It is one of the most anticipated projects in Warsaw, apart from the highway bridge on the Warsaw Southern Bypass.

5 ARMII KRAJOWEJ ROUTE S8 IN WARSAW

The section of the Armii Krajowej Route from Modlinska junction in Warsaw to Pilsudski junction in Marki has been upgraded to meet the parameters of the S8 expressway – a huge project, carried out in an urban area. It will greatly improve circulation for local traffic and ease of transit for vehicles passing through the city. Our task was to provide a total of 72 expansion joints for 26 structures. All deadlines were very tight. Despite some initial challenges, we succeeded in manufacturing and installing the devices on each structure. We are particularly satisfied with our work on this project because it forms part of our route into the BBR Polska office – we can now drive over our own excellent expansion joints!



6 ZWIRKI 1 WIGURY STREET FOOTBRIDGE

ZDM, the Municipal Roads Authority in Warsaw, has embarked upon the renovation footbridges in the city. For one of these, we created a suspension bridge using PT bars and this will be seen by many foreign guests arriving in Warsaw as it passes over Zwirki I Wigury Street – named after two famous Polish pilots – and leads to Okecie Airport. This could be why city authorities decided to honor the Polish heroes by creating a pylon shaped like a letter 'V' – for Victory. Banners welcoming visitors to the Euro 2012 football championships have already been fixed onto the structure.

7 WIDAWKA RIVER BRIDGE

Driving across Poland, one occasionally encounters a detour or repairs being made to local roads. The post-tensioned bridge over the small Widawka river is one such example of a task being carried out on a reconstructed provincial road. It is a small two-spanned structure with two beams of a total length of 48.4 m. We have delivered and installed 12 BBRVT CONA CMI 1906 PT tendons and six TOBE pot bearings for the project.



TEAM & TECHNOLOGIES

1 2 3 4 5 6 7

BBR NETWORK MEMBER BBR Polska Sp. z o.o. (Poland)

2 3 5

OWNER General Directorate for National Roads and Motorways, Warsaw

4 6

OWNER Municipal Roads Authority, Warsaw

1 POZNAŃ WESTERN BYPASS

OWNER General Directorate for National Roads and Motorways, Poznań

MAIN CONTRACTOR Skanska SA in consortium with INTERCOR Sp. z o.o.

DESIGNER Scott Wilson Ltd. z o.o., in partnership with ARCADIS Sp. z o.o.

TECHNOLOGY BBRVT CONA CMI internal Expansion joint
BBRVT TOBE pot bearing
Launching

2 WARSAW SOUTHERN BYPASS S2 EXPRESSWAY

MAIN CONTRACTOR Consortium of Bilfinger Berger Construction SA, PRM Mosty-Lodz, INTERCOR Sp. z o.o.

DESIGNER DHV Poland Sp z o.o., in partnership with BBPK SA

TECHNOLOGY BBRVT CONA CMI internal
BBRVT CONA CME external
Expansion Joint
Stay cable

3 A2 MOTORWAY BYPASS – MINSK MAZOWIECKI

MAIN CONTRACTOR Consortium led by Construction Company Road and Bridge Sp. z o.o.

DESIGNER Tebodin SAP-Projekt Sp. z o.o., DOPRAVOPROJEKT a.s.

TECHNOLOGY BBRVT CONA CMI internal

4 NORTH BRIDGE ROUTE

MAIN CONTRACTOR Consortium: P.R.I. 'Pol-Aqua' S.A. Partners, Sando Budownictwo Polska Sp. z o.o., Construcciones Sanchez Dominguez – Sando S.A. & Kromiss-Bis Sp. z o.o.

DESIGNER Schüssler-Plan, bridge SC, SC OPTEM, TRANSMOST Sp. z o.o.

TECHNOLOGY BBRVT CONA CMI internal

5 ARMII KRAJOWEJ ROUTE S8 IN WARSAW

MAIN CONTRACTOR J&P-AVAX S.A.

DESIGNER

TRANSPROJEKT-WARSZAWA Sp. z o.o.

TECHNOLOGY Expansion joint

6 ZWIRKI I WIGURY STREET FOOTBRIDGE

MAIN CONTRACTOR WPM Mosty S.A.

DESIGNER WPM Mosty S.A.

TECHNOLOGY Stay cable
PT bar

7 WIDAWKA RIVER BRIDGE

OWNER Local Management of District Roads, Lodz

MAIN CONTRACTOR INTERCOR Sp. Z o.o.

PLANT DESIGN & CONSULTING PRI Kepno

TECHNOLOGY BBRVT CONA CMI internal
BBRVT TOBE pot bearing



THE IDEAL SOLUTION

NEW ZEALAND FIRST FOR BAND TECHNOLOGY

The BBR Network Member in New Zealand, **BBR Contech**, has undertaken its first project using **BBR VT CONA CMB band tendons** – and it’s proving to be the ideal solution. Their Project Manager, **Hugo Jackson**, describes the work associated with the project.

The tendons have been used to strengthen a four-lane, 545 m long cantilever bridge that services one of Auckland’s busiest arterial routes. The Tamaki River Bridge – known locally as the Waipuna Bridge – crosses the Tamaki Estuary and provides a vital link between the city’s southern motorway and the eastern suburbs.

The strengthening work complements a major project being undertaken by Transpower, the owner of New Zealand’s high-voltage power transmission network. The company is replacing overhead power lines in the area with underground transmission cables and getting these across the estuary means stringing them through the centre of this busy road bridge.

EXTERNAL STRENGTHENING

Owing to the extra load these cables will impose on the 37-year-old, precast, pre-stressed concrete bridge – and to ensure that it continues to perform for the motorists that use it – we were contracted to undertake the

strengthening work which uses **BBR VT CONA CMB external band tendons**. Tested and already approved and used in Europe, this post-tensioning system is eminently suitable for such external applications. Rather than being bonded to the structure, the band tendons were inserted into the central void of the bridge’s box girder; transferring forces to the structure via large steel anchorage beams installed at the end of each tendon.

STAGED STRESSING

At the factory, the strands were greased and individually sheathed with continuously extruded HDPE (high-density polyethylene). They were then grouped in parallel and enclosed in a rectangular extruded plastic sheath. This eliminated the need for grouting and protects the strands against damage and corrosion. Supplied rolled around large wooden reels, the tendons were then winched into the cavity of the box girder, then through the diaphragms and deviators, before being stressed and

locked off. Great care was taken to stage the stressing operations to avoid developing differential bending and torsion loads between the two adjacent box girders.

SAVINGS ALL-ROUND

The system can be used with a broad range of construction materials – including concrete, steel and timber – and allows for future re-stressing, de-stressing and replacement. It also makes it easy to undertake inspections and maintenance, which means considerable savings in time and costs.

We worked closely with the BBR Network’s band post-tensioning specialists to ensure the system was installed to international best practice. This included valuable input from Munich-based BBR Network Member **Vorspann-Technik** who assisted with specific detailing and specialist equipment and methodologies, as developed for similar projects in their market. By the time the project was completed, the team had installed three 150 m long tendons into each cell of the twin box girders. Each tendon comprises four layers of **CONA CMB band**, each containing four 15.7 mm diameter strands and a capacity of 3,200 kN per tendon. In order to future-proof the structure for when additional lanes are added, provision has already been made within the new end anchorages for the installation of 12 further **CMB band tendons**. ●

TEAM & TECHNOLOGY

- OWNER** Transpower
- MAIN CONTRACTOR** Fulton Hogan Civil
- DESIGNER** Beca Infrastructure
- TECHNOLOGY** BBR VT CONA CMB band
- BBR NETWORK MEMBER**
BBR Contech (New Zealand)



Value through INNOVATION



Located between the Barton Highway and Glenloch Interchange and passing through the suburbs of Kaleen, Bruce and Aranda, the Gungahlin Drive Extension (GDE) project was undertaken by the ACT Government to accommodate the ever-expanding population of Canberra's northern suburbs. Deirdre Allen of Australian BBR Network Member, **Structural Systems Limited**, outlines the project and SSL's work, as a specialist bridge contractor to BMD Constructions, on the 108.5 m long bridge constructed over Belconnen Way.

The existing bridge at Belconnen Way was constructed during Stage 1 of the GDE and carried both the northbound and southbound lanes of Gungahlin Drive. As part of Stage 2, a new bridge was required alongside the existing to carry the two southbound lanes of the road upon completion of the extension works. The Stage 2 Bridge was to be identical both structurally and aesthetically to the existing bridge →



IN FOCUS: Purpose-built formwork traveler

The formwork traveler consisted of two main components – the upper and lower assemblies – and weighed 52.5 t nominally, including the concrete counterweights, forms, platforms and barriers.

The upper assembly was formed primarily of two 1200 mm main beams – each sitting on two pedestals with 75 t rollers at the front and 20 t rollers at the back of the traveler. Three transverse beams were positioned to run between the beams at the front of the traveler and these supported the hanger bars carrying the segment formwork. This upper assembly ran on a guide rail pinned to the deck to ensure lateral guidance while the formwork was traveling.

The lower assembly comprised the lower form, which included the outer web and wing forms, and the inner form, which moved independently from the rest of the traveler.

The outer web form and the wing form – all one section – were adjustable to allow for the 100 mm change in web thickness for some segments. There was also an allowance for the form to be opened away from the poured segment giving the 50 mm clearance required to launch the traveler forward. This section was bolted to the lower form in whichever position was required. The lower assembly was supported by 44 26.5 mm bars connected to the upper assembly and to the previous segment, ensuring correct levels could be obtained across the segment and continuity of profile throughout the bridge.

Two 32 mm stress bars ran vertically through the main beams at the rear of the traveler, connected through a coupler to second bar cast into the bridge webs. These bars were stressed to 150 kN to counteract the concrete load while a segment was being poured. Once the concrete had reached strength, the bars were de-stressed and removed to allow the traveler to be launched forward – and 15 t of counterweights ensured stability during movement of the traveler.

– a three span structure, formed with a single cell post-tensioned reinforced box section and a span arrangement consisting of a main span of 53 m with approach spans of 27.5 m each.

ALTERNATIVE METHODOLOGY

The initial proposal was to build the bridge using conventional balanced cantilever construction as this was the method used to construct the Stage 1 Bridge. This construction method would allow Belconnen Way to remain open for the extent of the works, however would involve the use of a large formwork traveler which, for the relatively small main span, was cumbersome and slow to erect and relocate. Also, an approximate break in program of 30 days would be required to dismantle the traveler upon completion of the first half of the structure, then move and reassemble on the other side of the bridge, prior to recommencing production.

After reviewing these drawbacks, we put together an alternative proposal which involved constructing the end spans of the bridge using traditional formwork while utilizing a single formwork traveler – designed by us specifically for the project – to construct the main span. This solution would significantly reduce the size of the traveler, thus making it easier to move, assemble and operate. Furthermore, the proposal included constructing the first main span segment beyond the pier using the traditional formwork, which ensured all the segments to be constructed using the formwork traveler were of equal segment depth for ease of construction and to reduce the complexities of the traveler.

The proposal was presented to BMD and the considerable cost and time saving benefits that accompanied this innovative approach led to us being awarded our first travelling formwork project in Australia.





SCOPE OF WORKS

Along with the design and supply of the formwork traveler, we were responsible for the supply and installation of post-tensioning materials, stressing and grouting of tendons, abutment jacking for bearing placement and supply of engineering design support – including monitoring of deflections and precamber adjustment during the construction of the bridge.

The alternative methodology we produced for the construction of the bridge required substantial re-engineering of the structure to allow for the change in construction method and sequence.

This bridge engineering service was also provided by us as part of our contract and included the re-design of the cantilever and post-tensioning.

As part of the formwork traveler package, operational drawings and step-by-step instructions were produced outlining the assembly and travelling procedure for the main contractor. We provided supervision during the initial stages to answer any queries or concerns regarding the traveler operation and, over the course of project, members of our post-tensioning crew were on site to provide any further assistance required.

PT INSTALLATION

The post-tensioning for the bridge consisted of BBRVT CONA CMI 1206 and 1906 anchorages. All of the tendons within the structure were double live and contained

15.2 mm diameter low relaxation strand.

On each side of the bridge, 20 12 strand tendons provided the prestress in the cantilever during construction – the longest tendon was 52 m long. Utilizing 80 1206 anchorages, four tendons were anchored at the end of each segment, up to the closing segment of the main span. When the segment had reached strength, the traveler was launched forward for the next segment pour and, in this position, provided a safe working platform over Belconnen Way for the installation of the four anchored tendons. These tendons were then stressed from the anchorage located at the abutment end. Six 23 m long 12 strand tendons were located through the end spans



to provide continuity stressing. Each tendon was anchored at the abutment face and in blisters within the box at the other end, there were 24 1206 anchorages in total. As with the cantilever stressing, these tendons were stressed from the anchorage at the abutment.

The continuity prestressing in the main span consists of 10 19 strand tendons – with 20 1906 anchorages located in blisters within the box – the longest tendon measures 45 m. These tendons had to be stressed from inside the box and this, therefore, presented some challenges in maneuvering the 1.1 t stressing jack and working within a depth less than 1,500 mm in the main span segments. A chain block and pulley system was the final solution, with the stressing jack sitting on a basic trolley and the traveler penetrations through the top slab of the deck – which, at this point, was not in use – utilized as lifting points to attach the pulleys.

UNCOMPLICATED VALUE

We were awarded the project on the basis of the significant savings our value engineering achieved for the main contractor. Providing the traveler engineering, post-tensioning and bridge engineering services in one package ensured these integral aspects of the works were fully coordinated. Furthermore, our re-engineering enabled a less complex construction method and faster site progress to be achieved compared to the initial concept. ●

TEAM & TECHNOLOGY

OWNER ACT Government

MAIN CONTRACTOR BMD Constructions

DESIGNER AECOM Australia Pty Ltd

TECHNOLOGY BBRVT CONA CMI internal
Balanced cantilever

BBR NETWORK MEMBER

Structural Systems Limited (Australia)



Poland's longest bridge

Polish BBR Network Member, **BBR Polska** has the major accolade of having worked on the construction of the longest bridge in Poland. Jacek Sowa, their cantilever bridge specialist, provides a brief summary of the two year struggle to construct the nearly two kilometer long bridge in Grudziadz.

In October 2011 – three years after the first spade of soil was dug – the 62 km Grudziadz to Torun section of the A1 Motorway was finally opened. A vital part of this new stretch of motorway is a bridge over the River Vistula, near Grudziadz.

BRIDGE OVERVIEW

Grudziadz Bridge consists of three sections. Firstly, the 988.8 m long longitudinally launched north overpass was constructed in 43 sections and launched from one side.

Then, there was the main bridge which is a three span cantilever superstructure and features a 180 m concrete span – the longest concrete span in Poland. Finally, the project included a 556.8 m long incrementally launched overpass with 25 sections, each 24 m long.

CANTILEVER DESIGN

As one of the main subcontractors for this structure, we participated in the design of the cantilever section, supplied and serviced formwork travelers, supplied internal and

Local insight: Grudziadz



Constructed from red brick some three to four hundred years ago, the imposing buttressed granary buildings are one of the best known features of Grudziadz. In bygone years, as well as serving as grain storage space, these ancient structures – some as high as seven storeys – were also used as part of the city's defenses against invaders.

Grudziadz first appears in written documentation in the 11th Century and, in 1522, it was here that Nicolaus Copernicus famously presented his thesis on monetary systems. By the end of the 19th Century, the city had established a power and gas plant, water and sewerage systems, a street tram network and a number of major industrial plants.

The city's geographic location – on the banks of the mighty Vistula River and on trading routes – ensured Grudziadz would thrive commercially. Today, the city has a population of over 100,000 people and specializes in metal, chemical, construction and light industry.



“ WE PROVIDED 25 STAFF, SUPERVISED BY TWO ENGINEERS, WHO WORKED CONTINUOUSLY FOR A WHOLE YEAR. ”

external stressing technology – the latter amounting to a total of 2,275 t of steel. Finally, we also supplied modular expansion joints – the largest of which had a 900 mm gap.

SPEEDING PROGRESS

Originally, it had been planned to build the two carriageways separately, but many delays forced the main contractor to speed up works and build all three sections at the same time. We provided 25 staff, supervised by two engineers, who worked continuously for a whole year. Despite heavy winters, unexpected floods and the tight schedule, we once again proved that our team is the best for this type of work in Poland. Meanwhile, our colorful form travelers – eight sections, each in a different color – are now stored and waiting for a new challenge!

TEAM & TECHNOLOGY

OWNER Gdansk Transport Company
MAIN CONTRACTOR SKANSKA NDI
DESIGNER Wanecki Sp. z o.o. Firma Projektowa BBR Polska, in collaboration with CEPAS, Switzerland
TECHNOLOGY BBR VT CONA CMI internal
 BBR VT CONA CME external
 Balanced cantilever
 Expansion joint
BBR NETWORK MEMBER
 BBR Polska Sp. z o.o. (Poland)

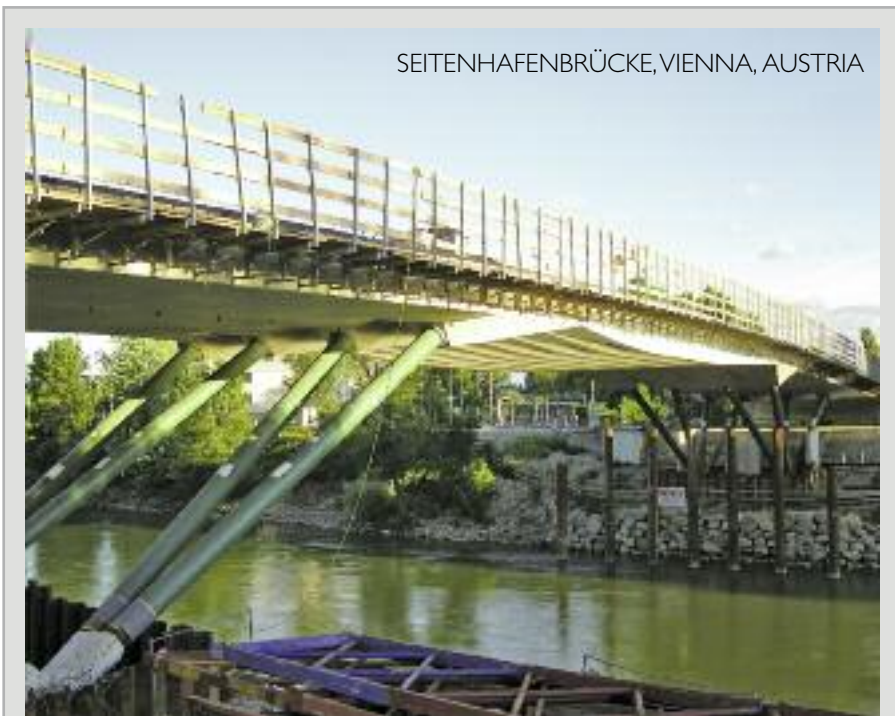

SEITENHAFENBRÜCKE, VIENNA, AUSTRIA

Resolving challenges

Vienna Harbor, located to the east of the city, is a dynamic and growing transfer site on the Danube River in Austria. To ensure an optimized transport connection with the road linking to the nearby A4 motorway – the main connection to Slovakia and Hungary – a new route has been constructed. Norbert Bogensperger of Austrian BBR Network Member, **Vorspann-Technik** provides a brief insight into the project.

In total, this new road section is about 2,000 m long and the Donaukanal, an inland waterway through Vienna – built 140 years ago, during Danube regulation works – had to be crossed. This bridge was designed as an integral bridge without moveable bearings and built in three stages. The two side spans are each 32 m long and the mid span is 65 m, giving a total length of about 130 m – and, with a width of 15 m, there will be plenty of room for vehicular traffic, as well as pedestrians and cyclists. It is a very slender, elegant construction, with two pairs of steel columns in each of the four

steel casting knots – two on each riverbank.

After erecting the two side spans, the mid span had to be constructed with no interruption to normal river traffic – which, amongst other river-users, included the Twin City Liner; a high speed Catamaran connecting Vienna and Bratislava.

For the post-tensioning, we used the BBR VT CONA CMI 1206 system and after stressing, all deformation in the deck was frozen off.

All the challenges of design and construction – such the as disconnection of dams and abutments, bored piles with elastic foundations and even moveable duct-joints for the PT system – were at last resolved.



TEAM & TECHNOLOGY

OWNER MA 29, Magistrat der Stadt Wien
MAIN CONTRACTOR STRABAG SE
DESIGNER pcd-ZT GmbH
TECHNOLOGY BBR VT CONA CMI internal
BBR NETWORK MEMBER
 Vorspann-Technik GmbH (Austria)



PISUERGA RIVER BRIDGE,
VALLADOLID, SPAIN

Mixed tendon tactics

The new bridge over the River Pisuerga in Valladolid, was inaugurated in Spring 2011. Also known as Santa Teresa Bridge, it now links the neighborhoods of Rondilla and La Victoria. Jose Luis Plaza of **BBR PTE**, the BBR Network Member in Spain, reports that construction work, performed by FCC and Isolux in joint venture, was completed in 14 months to a budget of €14.7 million.

This bridge connects Rabida and Peseta Streets and is 28.3 m wide. It has:

- ▶ Two 3.5 m wide vehicle lanes, with 2.4 m wide planters on either side to separate the traffic from the pedestrian zone
- ▶ A 3.2 m wide bicycle lane.
- ▶ Pedestrian sidewalks of 5 m and 8 m wide, with glazed railings.

The contract also included the development of the adjoining streets and three new roundabouts to absorb the traffic generated by the new infrastructure – and future developments planned for the northwest of the city.

ENVIRONMENTAL STUDY

Before starting work, an environmental impact study was carried out into the effects that construction might potentially have on the species of the area. As a result of this, the optimal timing for the works was established as being spring and summer, when the effects on the local wildlife would be lessened.

BRIDGE DESIGN

The 194 m long bridge, which has four intermediate piers, is divided into five continuous spans – 19 m + 25 m + 30 m + 90 m + 30 m – the 90 m span crosses the river. The double cell box girder is of variable height.



INTERNAL & EXTERNAL PT

This project was executed using BBR VT CONA CMI and CME 2406 and 2706 systems, with stressing and fixed anchorages at both ends. The whole structure contains around 102 t of 15.2 mm diameter post-tensioning strand.

Spans 1 & 2: These are concrete structures with corrugated steel sheaths. Here, some of the PT tendons are linked to the next span with couplers. We used some tendons with 24 strands and these run in a 110 mm inner diameter sheath. The remaining tendons, which contain 27 strands, have couplers in the section between piers 1 and 2 and are continuous in the next span.

Spans 3 & 5: These are of composite steel and concrete construction. The first part is concrete and the next steel, with concrete top and bottom slabs. For these spans, we used 27 strand tendons. The first part of the tendon sheath is a 128 mm inner diameter steel strip. Some tendons make the transition to a 140 mm outer diameter polyethylene sheath within the concrete section, ending in external metal trumpets supported against the steel frame. There were also new tendons in this span with fixed anchorages in one of the end tendons.

Span 4: Essentially, this is a metal box with a concrete top slab and was not post-tensioned.

MIXED TENDONS

Several tendons were housed in a metal strip sheath in the concrete section and in polyethylene within the steel section, in Span 4. Before concreting the first section, a polyethylene sheath was left protruding from the concrete. This was stretched until long enough to allow mirror welding later and did not protrude so far that it was in the way of

“ THE WHOLE STRUCTURE CONTAINS AROUND 102 T OF 15.2 MM DIAMETER POST-TENSIONING STRAND. ”

setting up work for the next steel span section.

Special care was taken in supporting the sheath and attaching it to the stretchers, as well as taping the joints – because the installation of tensile elements only took place after concreting. At the high point of the polyethylene sheath, a drain was installed – and was well taped to keep out concrete. After the steel box sections were placed in their final positions in both sides of the central span, we were able to complete tendon assembly. Metal trumpets were placed against the steel sections, after which we took care to measure very accurately the remaining length of polyethylene sheath required – we

assumed the ends would have welded stubs. Once this polyethylene section was prepared, it was welded to the protruding sheath – from the previous section – and then, using a metal ring, it was screwed to the trumpet at the end of the stub. Before fixing, a bead of silicone was applied to the surface facing the trumpet stub to improve sealing.

The placement of the metal trumpet was done with much care, bearing in mind that purging would be carried out in an upwards direction. Each trumpet has two stops that were placed against the brackets welded to the sides, so that they were set against the metal frame at the point where the sheaths were joined.

STRESSING OPERATIONS

To balance the forces introduced during the post-tensioning process, some tendons had to be stressed using two multistrand 750 t hydraulic jacks which were connected with a unique hydraulic pump. Stressing was carried out using both jacks at the same time and completed symmetrically in respect to the axes of the two concrete boxes.

In the abutment, we installed two 50 mm diameter PT bars which were stressed to transmit retaining vertical and horizontal forces between the deck and abutment. ●

TEAM & TECHNOLOGY

OWNER City Council of Valladolid

MAIN CONTRACTOR UTE FCC Construcción + Isolux Corsan

DESIGNER Arenas & Asociados

TECHNOLOGY BBR VT CONA CMI internal
BBR VT CONA CME external

BBR NETWORK MEMBER
BBR PTE, S.L. (Spain)



SUNGAI TERU CROSSING, MIRI,
SARAWAK, MALAYSIA

The proposed highway along Beluru, Long Teru and Long Lama crosses the Teru River, opening up interior rural areas for development. Originally, **BBR Construction Systems Malaysia** was contracted to carry out the post-tensioning works for the new river bridge – however, to improve buildability of the bridge, their scope was extended to include construction engineering. Engineer Yan Man Chung describes how this is being achieved by modeling the structure using FEM, simulating the stressing sequence and with the application of BBR Type K couplers.

The bridge configuration was 27.6 m + 52 m + 27.6 m and the main challenge of this project was to decide on a good construction method – as the consultant's drawing specified neither the method, nor the sequence of construction. Initially, our client proposed to construct both side spans on heavy duty scaffolds. After stressing the cantilever tendons, the formwork and all scaffolds were to be maintained until construction of the middle span over the river had been completed. The six pre-cast post-tensioned I-Beams for the center span would be launched from a temporarily backfilled access road. Next, the two stitching gaps between the main span and side spans would be cast. Finally, the continuity tendons would be stressed from abutment-to-abutment and all the formwork and scaffolds at side spans removed.

PRACTICAL METHODOLOGY

By introducing a 1905 BBR Type K coupler, the continuity tendon temporarily became a single parabolic span tendon within the side span. When stressed, it was able to support the weight of the 27.6 m side span beams. Therefore the props and formwork could be removed and reused on the other side span, generating savings in the cost of formwork and props.

The cantilever tendons over the top of piers were also stressed to hang the three



Engineering for buildability

temporary steel trusses for in-situ casting of the central span beams. Each beam was cast and its span tendons stressed before proceeding to cast the next beam, as the trusses could only support the weight of one concrete beam. Next, strands were threaded into the continuity ducts and coupled to the Type K coupler anchor heads. Then the two 1.4 m long stitching gaps were cast. Upon completion of stressing the continuity tendon, they were equivalent to the consultant's original design.



DESIGN CHECK

Analysis was carried out to check the bridge superstructure design at each construction stage to ensure the proposed construction method was safe and did not overload the capacity of constructed elements and that the temporary structure would be stable. Complete bridge modeling, using Finite

Element Method (FEM), was used to simulate the actual behavior of bridge at every construction stage. Elastic springs – taking compression forces only – were created to model support scaffold legs. Also, the concrete stresses were checked for compliance with the allowable limits.

DEFLECTION CONTROL

In this particular project, the final bridge profile had to be controlled to within +/-15 mm. We were also engaged to perform the deflection control during construction.

Total deflections at each construction stage were estimated from the bridge model – with a timeframe specified by the client – to predict the behavior of the bridge during construction. Then pre-camber values were proposed, based on the total deflection estimated, to achieve the final bridge profile. With BBR Type K couplers, our client managed to construct the bridge using only one set of scaffolding and formwork for the two side spans. By working closely with their temporary works designer, they were able to construct the middle span safely and economically. Finally, our client also benefited from the BBR Network's construction engineering and deflection control. ●

TEAM & TECHNOLOGY

OWNER Public Works Department, Malaysia

MAIN CONTRACTOR

Cityon Development Sdn Bhd

TECHNOLOGY BBR CONA internal

BBR NETWORK MEMBER BBR Construction Systems (M) Sdn Bhd (Malaysia)

Cantilevering FOR COMFORT

TRAUNBRÜCKE, A1 MOTORWAY,
STEYRERMÜHL, AUSTRIA

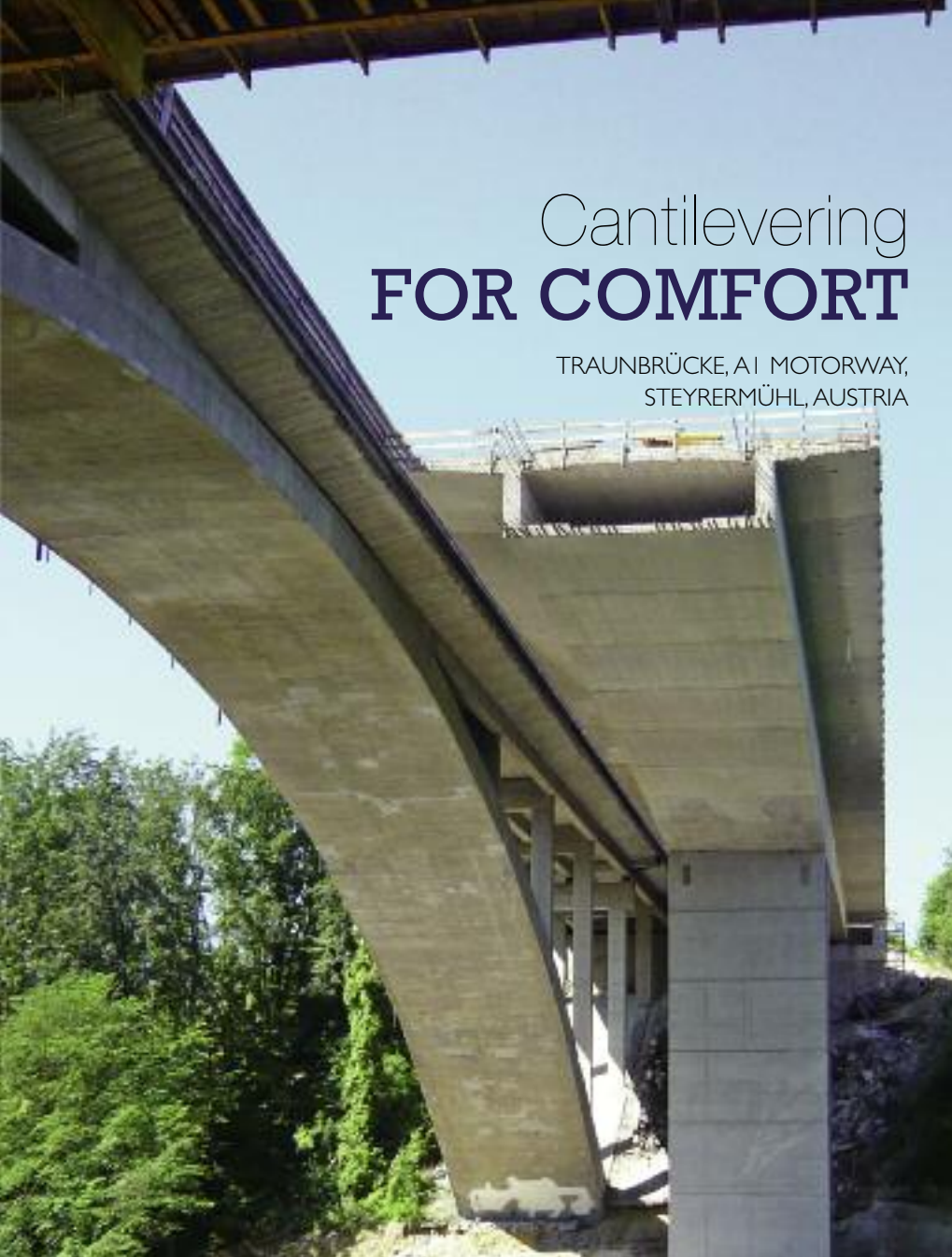

After 50 years of intensive use and steadily increasing load, the life cycle of the twin-arched Traunbrücke bridges at Steyermühl has ended. Construction is now underway to replace these bridges which support the two carriageways of the Vienna-Salzburg section of the A1 Motorway.

So that traffic flows can be maintained on this important East-West connection, the two bridges are being constructed consecutively. Work started with the spectacular blasting of the Salzburg carriageway down into the Traun river. After erecting the first pier on the west bank, the operation was repeated on the east bank for the second pier – then the free cantilevering of eight segments began. Together with the two foreland bridges, the overall length of the new bridge is around 240 m and, with a deck width of 12.75 m – instead of the 11.50 m offered by the previous viaduct – greater comfort and

enhanced road safety will be assured. The post-tensioning was designed with BBR VT CONA CMI 1206 and 0906 and carried out by BBR Network Member **Vorspann-Technik**. Grouting according to EN 445-447 was executed for the first time in Austria.

Within 13 months of the demolition of the old carriageway, the new bridge opened for traffic and the construction cycle started again. By summer 2012, when both carriageways will have been rebuilt, the general renewal of the 300 km long A1 Motorway – which has taken 15 years – will almost be finished.

TEAM & TECHNOLOGY

OWNER ASFINAG (Austrian National Motorway Authority)

MAIN CONTRACTOR STRABAG SE

DESIGNER KMP ZT GmbH

TECHNOLOGY BBR VT CONA CMI internal

BBR NETWORK MEMBER

Vorspann-Technik GmbH (Austria)



ODRA VIADUCT, ZAGREB, CROATIA

Ramping up at Odra

The Odra Viaduct is a part of the connection ramp for the Zagreb-Sisak motorway interchange in Odra. Damir Pavicic of **BBR Adria** explains that this ramp viaduct is 390 m long and was built in three parts using traditional formwork and scaffolding. The second part crosses the motorway and railway tracks and, because of its larger spans, it had to be prestressed. This part of the viaduct is 125 m long and 7.76 m wide with spans of 21 m + 3×28 m + 20 m. It has a 120 cm thick cast in-situ prestressed reinforced concrete slab with side cantilevers of variable thickness.

BBR VT CONA CMI 1906 tendons connect two spans alternately with four tendons stressed in each span. The total weight of tendons installed is 23 t and we used 32 BBR VT CONA CMI 1906 anchors. All works were finished in just two months.



TEAM & TECHNOLOGY

OWNER Hrvatske Ceste d.o.o.

MAIN CONTRACTOR Zagorje Tehnobeton d.d.

DESIGNER Jadranka Ivkovic, IGH Zagreb

TECHNOLOGY BBR VT CONA CMI internal

BBR NETWORK MEMBER

BBR Adria d.o.o. (Croatia)



LAS LLAMAS BRIDGE, SANTANDER, SPAIN

SPANNING URBAN GREEN

The new bridge over the valley in Santander's urban park – Parque Las Llamas – now connects the city on either side of this wonderful green space. With its spectacular white concrete bowstring arch, the bridge is destined to become an architectural highlight of Santander. Jose Luis Plaza from BBR Network Member, **BBR PTE**, reviews the construction project.

The Parque Las Llamas continues to grow, with a further 5,000 m² being incorporated into this 300,000 m² green swathe which stretches from the Estadio Sardinero sports stadium to the new bridge. The park grows under and around the bridge and features small private farm buildings – adjoining private land will, eventually, become part

of a great park of a million square meters or more.

The new bridge itself has, as anticipated, not only made a favorable impression on the local landscape, but has also



immediately become a vital piece of infrastructure. In addition to providing an aesthetic reference point, in a city of otherwise unremarkable architecture, it has rectified the lack of interconnection between two key areas. The north side of General Davila, which is behind Avenida de Los Castros, the physical border with the valley of Las Llamas, is

now connected with the new residential neighborhoods of Valdenoja, Cueto and Monte, where 6,000 homes have been built in the last decade and also with the S20 motorway which borders the valley.

DESIGN & CONSTRUCTION

Both the nerve center of the deck – the white concrete arch – and the foot of the bridge were constructed in-situ, while the sidewalks and walkways were prefabricated and assembled on site. In total, 86 pieces weighing 13 t each, were transformed into a 23.6 m wide bridge with two sidewalks, two vehicle lanes in each direction and a bicycle lane in the center.

This new arch bridge has been post-tensioned with 12 longitudinal BBR VT CONA CMI 1906 tendons made of 15.2 mm diameter strands and features 32 mm active transversal PT bars, both in the central section and in the lateral





prefabricated segments. For both ends, we used 64 mm diameter 460 N/mm² stainless steel PT bars with fork end connections. The installation was carried out such that the tension rod system is accessible for repair or maintenance at any time. Struts were pinned in the upper anchorage, to the steel plates previously inserted into the concrete arch – each anchorage has four 25 mm diameter 1,030 N/mm² PT bars.

STRESSING OPERATIONS

Struts were stressed symmetrically in respect to the axis of the arch. Two jacks were placed on the central bars of the lower plate anchorage and these were simultaneously stressed to the first stage. The force exerted on the hangers was recorded by calibrated gauges on the jacks. An independent check on the accuracy of these was provided by the load cells and extensimetric strips which we had placed earlier.

After all the central bars of the struts had been stressed, we then post-tensioned the longitudinal tendons and, lastly, the bars of the transversal central box. Once this stage was completed, the installation of prefabricated segments began on both sides of the central box. Four 32 mm diameter 1,030 N/mm² PT



bars were coupled to the central bars and stressed to complete the installation of these elements.

Once all prefabricated segments had been installed, the upper slab – joining the central box to the prefabricated segments – was concreted in three stages to balance the introduction of dead forces. Later the clearance between the lower strut anchorage and upper slab concrete box were filled with grout.

Finally, all the strut bars were re-stressed until they reached their final force. All bars were protected against corrosion by a layer of cement grout injected into the ducts enclosing the bars.

The bridge is required to play a leading role, both day and night. In daylight hours, its graceful figure is silhouetted against the Sports

Palace, in the east, or against the Picos de Europa mountains, in the west – while, at night time, its carefully designed lighting creates a magical glow over Las Llamas park. No normal streetlights here – indirect lighting has been arranged on the rails and strategically placed spotlights illuminate selected braces and feet. The points of light placed at the bottom of the deck permit a fuller appreciation of this structure which stands just 16 m above the river bed. ●

TEAM & TECHNOLOGY

OWNER Santander City Hall

MAIN CONTRACTOR Isolux Corsan S.A.

DESIGNER Arenas & Asociados

TECHNOLOGY BBRVT CONA CMI internal PT bar

BBR NETWORK MEMBER BBR PTE, S.L. (Spain)





The Nitra to Selenec section of the R1 Motorway is a 52 km long extension of the route between the towns of Banska Bystrica and Nitra, which is about 100 km east of Bratislava, the Slovakian capital. Norbert Bogensperger from Austrian BBR Network Member **Vorspann-Technik** explains that, to close one of the last gaps – and within the first Slovakian Private Public Partnership infrastructure project – a 1,165 m long bridge structure was built.

The bridge arches above the southern outer circle of Nitra, a railway line, some roads and the River Nitra. The structure consists of two sections – DC1 and DC2.

R1 MOTORWAY BRIDGE, NITRA, SLOVAKIA

CLOSING THE GAP

DC1: LAUNCHED MONOLITHIC BOX GIRDER

DC1 is a cyclically launched monolithic box girder – consisting of two independently built bridges side-by-side supporting the two carriageways. A single deck is 12.65 m wide and 804 m long. The spans vary – depending on the terrain – between 40 m and 45 m and pier heights range from 7.1 m to 10.9 m

DC2: PT CELL GIRDER

The superstructure of DC2, which crosses the river, is a five-span post-tensioned cell girder consisting of three cells and a deck width of about 26 m.

We used the BBR VT CONA CMB external band post tensioning system, all designed as 04 x 0406 which means four bands with four strands each. This system was also used in both structures – for DC1, as well as DC2 – with lengths mainly between 151 m and 177 m.

TEAM & TECHNOLOGY

OWNER GRANVIA Construction, s.r.o. (PPP)

MAIN CONTRACTOR A-Hid Epito Zrt.

DESIGNER DOPRAVAPROJEKT, Bratislava

TECHNOLOGY BBR VT CONA CMB band

BBR NETWORK MEMBER Vorspann-Technik GmbH (Austria)





RIBNICA BRIDGE, PODGORICA, MONTENEGRO

High quality access route

The 8 km long Podgorica Eastern Bypass is the most expensive and demanding infrastructure project recently built in the capital city of Montenegro, recounts Damir Pavicic of Croatian BBR Network Member, **BBR Adria**.

Construction of this project, to echo the words of Podgorica's Mayor, is significant – not only for the City of Podgorica, but for the whole of Montenegro – because it provides an easy, high quality access route to the sea and port of Bar, as well as important commercial destinations and neighboring countries. Professor Mladen Ulicevic, the lead designer, describes Ribnica Bridge as the biggest structure on Podgorica's bypass. The bridge consists of four 3.5 m wide traffic lanes, a pedestrian lane and protective lane. On the right, downstream side, the bridge is 9.61 m wide, whilst on the left side it is 10.67 m wide. A separate 290 m long structure was built for each carriageway. The bridge was designed as modern post-tensioned construction with nine spans of 30-35 m and 10 m high piers. It was post-tensioned using BBR VT CONA CMI 1206 and 1506 tendons. A total of 107 t of PT strand were used in the construction. The superstructure was built in five months using traditional formwork and scaffolding.

TEAM & TECHNOLOGY

OWNER

City of Podgorica, Agency for Construction and Development d.o.o.

MAIN CONTRACTOR Celebic d.o.o.

DESIGNER prof. Mladen Ulicevic, CDS Project d.o.o.

TECHNOLOGY BBR VT CONA CMI internal

BBR NETWORK MEMBER BBR Adria d.o.o. (Croatia)



BRIDGES

A1 MOTORWAY, UPPER SILESIA, POLAND

RECORD FOR SILENT JOINTS

In the densely urbanized and industrialized region of Upper Silesia, Poland, **BBR Polska** is responsible for the delivery and installation of expansion joints on the 36.2 km long Maciejow to Pyrzowice section of the new A1 motorway.

The range of work includes production, delivery and installation of single and modular expansion joints for the project. This is a highly complex construction project because it is taking place in a coal mining area. The effect of mining operations causes ground settlement and this can often amount to as much several meters over the years. So, during the design phase, the potentially large movements of the main structure had to be taken into account when specifying expansion joints.

We are delivering 122 expansion joints, 86 of which are modular joints with a total length of almost 2,000 m. The largest joints have a possible longitudinal movement range of +/-480 mm and +/-90 mm transversally. In addition, this was the first time expansion joints with noise reduction features had been used in Poland. These rely on the installation of sinus plates on the top of the joint and installation of special soundproof mats. As cars cross over a joint, these elements then combine to make a significant reduction in the attendant noise levels. The joints were completed with extra reinforcement, provided by polymeric concrete.

TEAM & TECHNOLOGY

OWNER General Directorate for National Roads and Motorways (GDDKiA), Katowice Division

MAIN CONTRACTOR Budimex S.A. & Dragados S.A.

TECHNOLOGY Expansion joint

BBR NETWORK MEMBER BBR Polska Sp. z o.o. (Poland)



Strong and healthy

ROYAL NORTH SHORE HOSPITAL REDEVELOPMENT,
SYDNEY, AUSTRALIA

To respond to emerging technologies and changes in clinical practice and population health, the New South Wales Department of Health, in a partnership with the private sector, provided the funds for the redevelopment of the Royal North Shore Hospital which lies five kilometers to the north west of Sydney's Central Business District. Sam Fassaie of BBR Network Member **Structural Systems Limited** shares some of the project's highlights.

The project is the largest ever health Public Private Partnership (PPP) undertaken in New South Wales. The PPP has enabled architects and planners to draw on the best ideas from around the world and deliver an expandable design that can grow and change in response to healthcare needs.

The redevelopment project includes a new main hospital building (Acute Care Facility), a new Community Health Building and the refurbishment of some existing buildings. When completed, the redeveloped Royal North Shore Hospital will offer:

- ▶ 462 acute beds to complement the 124 beds provided within the already completed Douglas Building

- ▶ 40 acute mental health beds
- ▶ Additional chemotherapy and renal dialysis chairs
- ▶ Enhanced diagnostic services and ambulatory care services
- ▶ A total of 29 procedure and operating rooms.

The Acute Care Facility is relatively low rise, with innovative color-coded internal spaces to help people navigate the hospital environment. The design maximizes local views, light and space to create a welcoming, healing environment, while the compact footprint ensures that every department is within two minutes walk of the main lifts. It will include new commercial and retail areas for the convenience of staff, patients and visitors.

We were commissioned by the main contractor to provide the design and installation of post-tensioning to the Acute Care Facility and the New Community Health Precinct. On top of the post-tensioning works, we were also awarded the contract for the slipform construction of four stair and lift shafts in the Acute Care Facility.

SPEEDY SLIPFORM

Due to the tight program, the main contractor examined different options for constructing the four sets of central cores that would directly affect the speed of constructing the 10 levels of the building. Slipform construction was the solution chosen to achieve the program, due in part to its superior speed, as



“ A NEW HELIPAD ... NEEDED A SPECIAL DESIGN BECAUSE OF THE LIMITED NUMBER OF COLUMNS, VERY LONG CANTILEVER – UP TO 7.5 M LONG – AND VARIABLE LOADING ”



well as flexibility in design and operation. The slipform technique is a rapid and economical construction method that can achieve considerable cost savings when compared with the cost of conventional formwork.

Each set of cores contained two to four lift shafts, plus fire escape stairs, which required a specific design, as well as specialized

equipment and installation. The slipform elements were assembled off-site and then transported to site for the final assembly. The existence of tower cranes within some of the lift cores demanded sophisticated steel frames to secure the yokes and panels in their places. Special provision and design were also in place for the numerous openings within the walls. We were able to run two slipforms at the same time to maximize the construction speed on site.

VIABLE ECONOMICAL SOLUTION

The column layouts are generally with 10.8 m and 8.4 m spans – almost impossible to design with conventional reinforcement. Consequently, the viable and economical solution to this arrangement was post-

“... THE VIABLE AND ECONOMICAL SOLUTION TO THIS ARRANGEMENT WAS POST-TENSIONING OF THE BEAMS AND SLABS FOR THE NOMINATED DESIGN LOADS.”

Facts & figures

- ▶ Suspended slabs – 106,000 m²
- ▶ Strand – over 625 km
- ▶ Ducting – over 160 km
- ▶ Engineering drawings – over 1,400 issued

tensioning of the beams and slabs for the nominated design loads.

The design of the Acute Care Facility's post-tensioned floors began in the second half of 2009. All of the slabs from levels 2 to 10 were designed and executed using the BBR CONA flat post-tensioning system. Level 2 alone is 15,500 m² and needed to be designed for a variety of loadings – including a loading dock, MRI and other medical equipment, the path for transporting equipment into place and many transfer columns.

As post-tensioned slabs are typically much thinner than conventional slabs, detailed analysis was carried out for vibration and noise to ensure the multitude of sensitive medical equipment – such as MRI or CT scanners – would function accurately. There were areas within the post- →





tensioned slabs where uncertainty prevailed about the location of the penetrations required for the services. As a result, certain areas were noted on our drawings as 'PT Exclusion Zones' to provide flexibility for coring in future. These areas were also marked up on the slabs during construction.

NEW HELIPAD

A new helipad is also part of the Acute Care Facility and needed a special design because of the limited number of columns, very long cantilever – up to 7.5 m long – and variable loading. Two different engineering design programs, RAPT and RAM Concept, were used to ensure the results were consistent and to verify design. Through our client, we liaised with the aviation authorities to ensure all possible iterations of loadings applied on this important structure were accounted for. The multitude of post-tensioning tendons made the centre of the helipad very congested with a large amount of stress in the concrete. As a result, dead ends of the tendons had to stagger within the depth and also across, so as to spread the

enormous stress in a larger section. Special analysis and detailing were carried out for the amount of reinforcement needed within that zone and also a higher grade of concrete – 50 MPa cylinder strength – was determined for this slab. The helipad is in a prominent position which makes it visible from many angles, even from Sydney Harbour Bridge – making the helipad a new monument for Sydney. We also designed and installed post-tensioning for the new Community Health Centre as part of the project. More than 60 t of CONA flat post-tensioning was installed in around 12,000 m² of slabs. Construction now completed, this building provides a range of facilities to support community health services. ●

TEAM & TECHNOLOGY

OWNER InfraShore Pty Ltd
MAIN CONTRACTOR Thies Pty Ltd
PT SLABS & SLIPFORM DESIGNER Structural Systems Limited (Australia)
TECHNOLOGY BBR CONA flat Slipform
BBR NETWORK MEMBER Structural Systems Limited (Australia)



REHEARSAL STAGE,
VIENNA OPERA HOUSE, AUSTRIA

Room for rehearsal



Norbert Bogensperger, of BBR Network Member **Vorspann-Technik** in Austria reports on a project for the world famous Opera House which is located on the Ringstrasse in the heart of Vienna. It was built between 1861 and 1869, in the Neo-Renaissance style typical of other famous Viennese buildings.

The problem with this historic building is that it offers too little storage space for scenery and just a small rehearsal stage, less than half of the size of the real stage. Thus, the decision was made to add on a full-scale 800 m² rehearsal stage to the existing scenery depot, a few kilometers away in the Arsenal area.

This allows even choral and mass scenes to be rehearsed using the original stage scenery which just has to be rolled a few meters out of the depot.

Architecturally, the new building appears to be a levitating cube. It is grounded just by four piers and the whole ground floor – at more than four meters high – is an open area for truck loading and storage.

Therefore, the 70 cm thick first floor slab was constructed with a special concrete and a tight cross-layering of BBR VT CONA CMM 0406 bands to handle these enormous spans of more than 25 m. ●

TEAM & TECHNOLOGY

OWNER ART for ART Theaterservice GmbH
MAIN CONTRACTOR Bilfinger Berger Baugesellschaft mbH
DESIGNER nowy-zorn ZT GmbH
TECHNOLOGY BBR VT CONA CMM monostrand
BBR NETWORK MEMBER Vorspann-Technik GmbH (Austria)

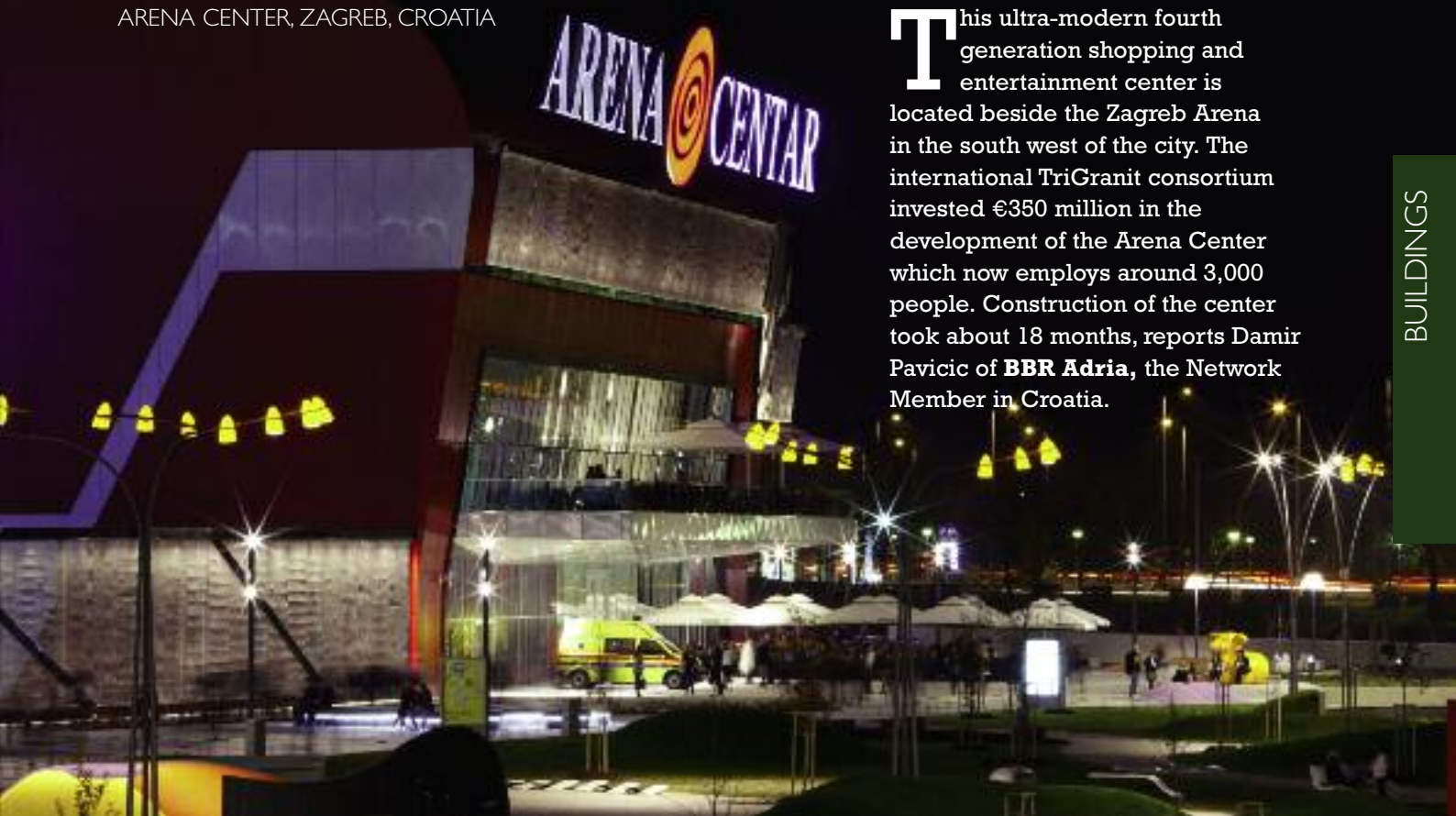

Creating space for retail and leisure

The Arena Center covers an area of 175,000 m² which accommodates more than 220 different shops, a bowling alley and a multiplex cinema with an IMAX theatre. There are 3,500 parking spaces, most of which are housed in one underground level. In an eight month period, we executed 72,000 m² of post-tensioned slabs using the BBR VT CONA CMM 106 unbonded system, with 150 mm² 1860 MPa strand. Some 420 t of steel prestressing strand was consumed. The PT slabs were designed using the shallow beam concept. The general column layout is 8 m by 16 m, except where supermarket design specifications demanded a 16 m by 16 m grid. The beam depth is 50 cm to 55 cm, with slab thicknesses of 20 cm to 25 cm, depending on the load requirement. The exception was a 16 m by 16 m area with a 60 cm beam and 30 cm slab. Tendons are banded only in beams in the 16 m direction – elsewhere they are distributed. Slender PT slabs enabled optimal space utilization and we managed to insert one additional slab in parking sections B and C. In section A, an 8 m wide PT strip was left in the middle to be cast and stressed at the end – because of its 144 m length. Section D is geometrically more complex, with cantilevering galleries and pedestrian bridges.



This ultra-modern fourth generation shopping and entertainment center is located beside the Zagreb Arena in the south west of the city. The international TriGranit consortium invested €350 million in the development of the Arena Center which now employs around 3,000 people. Construction of the center took about 18 months, reports Damir Pavicic of **BBR Adria**, the Network Member in Croatia.

Inside prefabricated sections, post-tensioning was also used in two places – due to geometrical complexity and big spans. One application involved a 6.9 m long cantilever used as a restaurant terrace right over the Arena's main entrance. The slab incorporating the cantilever was produced on a 16 by six meter grid, so that the cantilever was longer than the adjacent slab span. This demanding structure was resolved with a shallow beam grid 60 cm deep and a 20 cm slab. The second complex area was a side entrance in Section 4 with a curved beam spanning 18.5 m and a 9.5 m by 4.5 m light well opening. We found unbonded post-tensioning technology to be of great advantage – due to speed and practicality of execution, larger casting segments and faster working progress even in the winter months.

TEAM & TECHNOLOGY

OWNER TriGranit Laniste d.o.o. Zagreb
MAIN CONTRACTOR MI GRUPA (Mucic & Co, Medjimurje graditeljstvo & Tromont)
DESIGNER Berislav Medic, UPI-2M, Zagreb
 Miljenko Kovac & Predrag Presecki, K.A. biro, Cakovec
TECHNOLOGY
 BBR VT CONA CMM monostrand
BBR NETWORK MEMBER
 BBR Adria d.o.o. (Croatia)

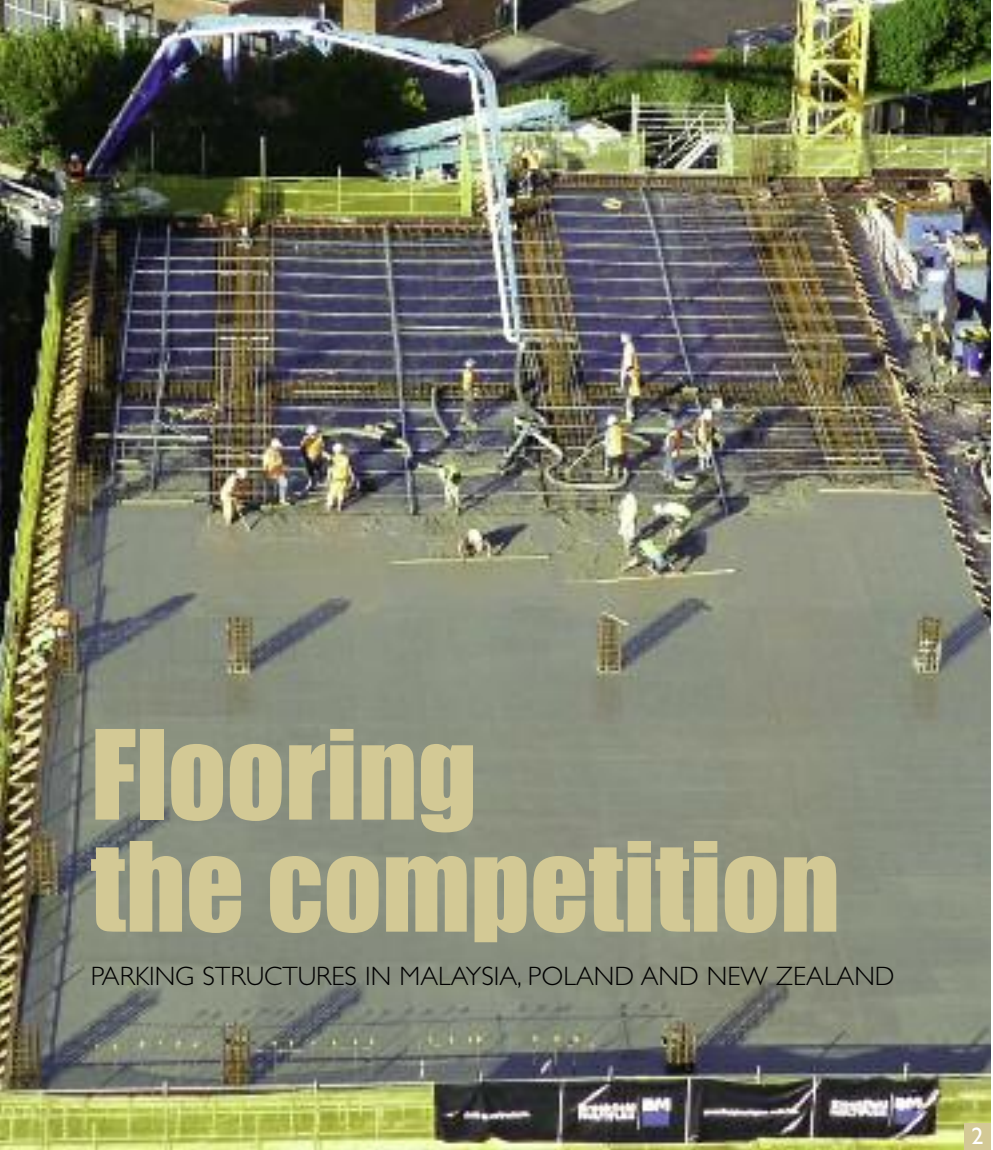

Flooring the competition

PARKING STRUCTURES IN MALAYSIA, POLAND AND NEW ZEALAND

The BBR Network's expertise has delivered innovative and market-leading floor solutions for specialist applications. By adopting a post-tensioned approach, our customers can be certain of both improved construction programs and higher performance.

We present details of three different slab projects here – one constructed by BBR Construction Systems in Malaysia, another by BBR Contech in New Zealand and a third by BBR Polska – which demonstrate not only technical excellence, but also the enhanced fitness-for-purpose of solutions based around BBR technology and know-how.

1 ALTERNATIVE GATEWAY TO MALAYSIA

Mika Jakau of Malaysia-based **BBR Construction Systems** reports how post-tensioned flat slab methodology is enhancing construction progress and providing economic savings to the construction of car park blocks at the new Low Cost Carriage Terminal (LCCT) next to Kuala Lumpur International Airport in Sepang. There are two seven storey car park blocks, with a total car parking area of 140,000 m² and with column grids mainly at 8.4 m by 8.4 m – and some areas 9 m by 9 m. Each 8.4 m and 9 m bay is divided by two intermediate beams, resulting in three slabs per bay.

To reduce formwork and labor costs while reducing program time, we proposed a post-tensioned flat slab approach, utilizing BBR CONA flat tendons. Each 208 m by 52 m floor of each block is divided into ten construction zones to suit the client's construction sequence. By changing the structure to flat slab, the client is able to use his existing table formwork, which gave him the competitive edge in securing this project.



2 ELEVATING PERFORMANCE

Having chosen a cast-in-situ post-tensioned concrete structure and experienced its significant construction and delivery benefits on our earlier Sylvia Park project together, main contractor Brookfield Multiplex is again involved with a car park. This time it is for a six-storey structure to provide 1,200 spaces for Auckland's North Shore Hospital. **BBR Contech** Project Manager Hugo Jackson outlines the details.

Comprising a total floor area of 27,700 m² – around 4,600 m² per storey – the floor contains approximately 170 t of post-tensioning. The floor structure consists of 150 mm thick concrete slabs with wide band beams in one direction and seismic resisting frame in the other. Each level is constructed as three pours on relocatable forms and a storey is completed on average every two weeks. Our post-tensioned flooring solution offers a number of benefits for car park structures like these. It is economical and relatively quick to install, and it saves material costs and construction time, while also enabling the client to reduce the distance between each parking level. It delivers a great surface too, providing users with a smooth driving and parking experience.

3 PYRZOWICE TECHNICAL HANGAR

Parking experiences of a different scale faced the BBR Network in the construction of the first ever post-tensioned slab on ground to be used in Poland for parking aircraft. Karolina Haponik of **BBR Polska** explains that the 6,400 m² slab, at the



Technical Hangar at Katowice Airport in Pyrzowice, was designed as a monolithic plate of post-tensioned concrete, divided into two mirror-image sections and separated by a 10 mm expansion joint.

Slab thickness varies – according to anticipated load factors – from 200 mm in the aisle, 250 mm on the outside apron, to 360 mm for the apron itself. Each section is divided into four further sections which were concreted in continuous pours, then stressed in two stages. Transverse tendons from sections 2, 3 and 4 were anchored in the main section, so that all sections

were stressed together. The main 360 mm slab was designed to transfer aircraft loads – concreting here lasted for 16 hours. We used BBR VT CONA CMM 0106 tendons with strands of 15.7 mm nominal diameter, 150 mm² cross-section and a tensile strength 1860 MPa. All strands were prefabricated on the prefabrication line within our own production plant and delivered on site in ready-to-install condition. ●

TEAMS & TECHNOLOGIES

1 LOW COST CARRIAGE TERMINAL

OWNER Malaysia Airports Holdings Berhad
MAIN CONTRACTOR WCT Construction Sdn Bhd
CLIENT TKM Resources Sdn Bhd
DESIGNER BBR Construction Systems (M) Sdn Bhd
TECHNOLOGY BBR CONA flat
BBR NETWORK MEMBER
 BBR Construction Systems (M) Sdn Bhd (Malaysia)

2 NORTH SHORE HOSPITAL

OWNER Waitemata District Health Board
MAIN CONTRACTOR Brookfield Multiplex
DESIGNER MSC Consulting
TECHNOLOGY BBR CONA flat
BBR NETWORK MEMBER
 BBR Contech (New Zealand)

3 PYRZOWICE TECHNICAL HANGAR

OWNER Gornoslaskie Towarzystwo Lotnicze S.A.
MAIN CONTRACTOR Polimex – Mostostal
DESIGNER P.S. Budoprojekt
 (PT slab on ground by SDS Sp. z o.o.)
TECHNOLOGY BBR VT CONA CMM monostrand
BBR NETWORK MEMBER
 BBR Polska Sp. z o.o. (Poland)

K-MART DISTRIBUTION WAREHOUSE, AUCKLAND, NEW ZEALAND

Recognizing concrete excellence

It is not often that concrete floors win prizes, but a project with which BBR Contech was associated has been recognised as an outstanding achievement in concrete construction and has earned top honors in the New Zealand Concrete Society's Concrete Awards 2011. BBR Contech Project Manager, Terry Palmer, describes this latest achievement. Concrete floor specialist Conslab was presented with both the Technology Award and the supreme Concrete Award for its construction of two floor slabs for a K-Mart distribution warehouse in South Auckland. One floor – smooth, flat, highly polished and post-tensioned – is inside the warehouse, and the other – a jointed steel fiber reinforced slab finished with a skid-resistant, free-draining surface – forms a truck loading and unloading area outside. Conslab called on us to design, supply and install the post-tensioning for the interior slab. Covering almost 13,000 m² with a thickness of 160 mm. It was created in four pours and stressed into one large slab with no free movement joints

By meeting the rigorous FM2 criteria of the European racking code EN 15620, it enables the owner to close up the spacing between racks to 'Very Narrow Aisle' (VNA) racking, with minimal grinding necessary to bring the slab to a defined movement specification. According to the judges, the project illustrated "a very comprehensive understanding of warehouse and hard-standing slab performance and construction" and "the exceptional level of concrete design and construction excellence that the Concrete Society Award demands." The surface flatness ensures high productivity for the forklifts – a key factor in logistics warehousing. The finished surface has high light reflectivity – a quality delivered by the floor's light color and high-gloss

finish which, together with the use of clear roofing, has reduced the warehouse lighting requirements. In addition, the 40 MPa concrete – highly burnished and well cured – has excellent abrasion resistance, ensuring a floor that will last for many years to come. ●



TEAM & TECHNOLOGY

OWNER Goodman Property Trust
MAIN CONTRACTOR Macrennie Commercial Construction
DESIGNER MSC Consulting
FLOORING CONTRACTOR Conslab Ltd
TECHNOLOGY BBR CONA flat
BBR NETWORK MEMBER
 BBR Contech (New Zealand)



DEE WHY GRAND, SYDNEY, AUSTRALIA

The Dee Why Grand is a new mixed-use development situated amidst Sydney's northern beaches. The development has formed part of Warringah Council's Dee Why Environmental Plan to rejuvenate the local area, bringing new energy and affluence to the Northern Beaches. George Marinos, of Australian BBR Network Member **Structural Systems Limited**, gives an overview of the project.

The project involves the A\$110 million redevelopment of the Dee Why Hotel and contains car parking, retail and commercial areas – together with six residential towers, rising three to eight storeys above a landscaped podium. We were contracted by Southern Cross Constructions to design and install the post-tensioning for the project.

DIFFICULTIES & CHALLENGES

The project presented a number of unique challenges, especially relating to the groundwork and basement construction below Dee Why's shallow water course. The largest piling rigs in Australia were used to install the 32 m sheet pile walls around the perimeter and the deep excavation now

hosts three basement car park levels and two levels of retail stores. A further challenge was that the structure had large floor plates with a considerable number of reinforced cast in-situ concrete cores positioned in several locations across the floor area. These rigid elements created restraint issues. Added to this, the lower levels which include the basement and retail levels were restrained by the sheet pile retaining walls. To deal with the restraint issue, both temporary and permanent movement joints were introduced to isolate from the reinforced concrete cores. Delayed conventionally reinforced pour strips were introduced around the perimeter to isolate from the sheet pile wall which also provided access for stressing and eliminated the need to use surface stressing pans.

PT SOLUTION

Post-tensioning was used throughout the suspended floors which are cast-in-situ concrete, incorporating more than 360 t of BBR CONA flat slab post-tensioning. The design of the suspended floors made use of a number of slab systems which include one-way slabs supported by band beams, two-way flat plate and two-way slabs with drop panels. The basement car park slabs were generally one-way slabs supported by band beams, the retail levels were flat plates with drop panels to allow for the passage of



“... A COMBINATION OF BBR CONA FLAT SLAB POST-TENSIONING AND BBR VT CONA CMI ... REDUCED CONGESTION AND IMPROVED THE CONSTRUCTION EFFICIENCY OF THE FLOOR.”

services without restricting head height and the residential floors were typically flat plate due to the head height constraint – 2.7 m ceilings. These slab systems were chosen with the aim of providing the most efficient and low-cost solution to the client. This was achieved by the attendant reduction in materials and increase in the speed of construction without compromising the structural integrity, quality or architectural requirements of the structure.

The Level 1 podium slab is a heavy transfer slab with complex concrete profiles due to the combination of varying slab thicknesses, deep folds and steps, large spanning beams – some in excess of 16 m – to cater for the large column-free space below required for the loading dock, diagonal beams and the magnitude and positioning of the transfer columns. Input from the design team was critical to arriving at a practical solution. The slab depths and beam dimensions were reviewed – in discussion with the consulting engineers, the architect and services consultants – and this led to significant changes in the concrete profiles. Due to the geometric confinements of some slabs and beams, we used 12.7 mm and 15.2 mm diameter strand.

In addition, the dimensions of various transfer beams were restricted in depth and width and could not be increased due to head height limitations – widths could only be increased to a certain extent. This created issues with practicality and great difficulties in physically installing the considerable quantity of post-tensioning strand required to control deflections. Therefore, the design of the beams used a combination of BBR CONA flat slab post-tensioning and BBR VT CONA CMI which reduced congestion and improved the construction efficiency of the floor. With the use of post-tensioning, thoughtful design and efficient construction, the project recovered from being well behind its target construction program – when we began the suspended structure – to finishing ahead of schedule on its completion.



TEAM & TECHNOLOGY

- OWNER** Dee Why Developments
- MAIN CONTRACTOR** Thiess Pty Ltd
- DESIGNER** Structural Systems Limited (Australia)
- TECHNOLOGY** BBR CONA flat BBR VT CONA CMI internal
- BBR NETWORK MEMBER** Structural Systems Limited (Australia)

Local insight: Dee Why



Today, Dee Why is undergoing considerable urban regeneration and proving popular with young professionals, perhaps attracted by an easy commute into the Sydney CBD. The first written reference to the town appears in the field book of Irish-Australian explorer and surveyor James Meehan: “Wednesday, 27th

Sept, 1815 Dy Beach – Marked a Honey Suckle Tree near the Beach.” Explanations for his description range from the DY simply being a code that he used on maps, or that it originally came from the local Aboriginal language or was derived from calculus and refers to the shape of the curve of the beach as seen on a map. From 1940, the town was known as ‘Deewhy’ and it was only in the 1950s that it took the present form – Dee Why. Since construction of the new civic centre in the early 1970s, the town has housed the administrative headquarters of Warringah Council, the local authority.

MAGISTRATES’ COURTS, ESSEX, ENGLAND
Reducing legal costs



Post-tensioning which was designed and installed by BBR Network Member **Structural Systems UK** has been used to reduce the environmental impact on two new Magistrates’ Court buildings currently being developed in Colchester and Chelmsford, Essex. **Richard Gaskill** takes up the story.

Both buildings were designed to sit on existing car parks and have a similar layout. During the initial design review workshops, some 50 potential design changes were identified with 11 ideas flagged up for further discussion and, finally, this number was distilled down to four which were analyzed in detail. Post-tensioning, along with retention of excavated material, pre-engineered stairs and CFA replacement piles reduced the overall cost of the structures. The Colchester structure had slab depths varying from 200 mm to 400 mm, whereas the one in Chelmsford varied from 200 mm to 500 mm thick. The Magistrates’ Court scheme was procured through a Private Finance Initiative (PFI) scheme by the County Council, to secure the new courts as part of a countywide court strategy. Her Majesty’s Court Service is expected to pay £30 million for the Colchester Magistrates’ Court Complex. The Court is due to hold its first case in summer 2012. The Courthouse is designed to the HMCS Design Guide 2007 and is set to achieve BREEAM excellent and other specific targets from the UK Government Framework for Sustainable Development.

TEAM & TECHNOLOGY

- OWNER** Her Majesty’s Court Service
- MAIN CONTRACTOR** Galliford Try
- TECHNOLOGY** BBR CONA flat
- BBR NETWORK MEMBER** Structural Systems (UK) Ltd



Stressing for new icon

ADNOC HQ, ABU DHABI, UNITED ARAB EMIRATES

The new corporate headquarters complex for Abu Dhabi National Oil Company (ADNOC) is being built on the Abu Dhabi City corniche. This magnificent 342 m high tower with excellent views of the Arabian Sea will be one of the tallest towers in Abu Dhabi. Roland Zachar, Design Manager and Warwick Ironmonger, General Manager, both from **Structural Systems Middle East**, the BBR Network Member based in the United Arab Emirates, report on the challenges overcome whilst designing and building this iconic building.

The new ADNOC headquarters occupies one of the most prestigious addresses in the United Arab Emirates and, indeed, in the whole of the Middle East. It stands immediately opposite the luxurious Emirates Palace Hotel and the new presidential palace which is currently under construction. The 75-storey ADNOC HQ building will achieve either Gold or Platinum LEED Certification upon completion, as the construction systems and methodologies employed will minimize the building's impact on the environment. Apart from office space, the tower will include a Corniche Club, the Supreme Petroleum Council and Crisis Management Centre, Heritage Museum and other supporting facilities.

STRUCTURE

The concept of the structure is very minimalistic, taking into account that the footprint of a typical level is approximately 2,450 m². Post-tensioned floors are supported on the west, south and east by

large cores and only six perimeter columns at nine meter spacing on the north side.

The south core reduces in size towards the top of the tower. Cores to the west and east do not diminish in overall size, but the thickness of their walls decreases with height.

“ PROBABLY THE BIGGEST CHALLENGE ... WAS TO SATISFY THE ENGINEER'S REQUIREMENT FOR A MINIMUM OF 50% OF THE TENDONS TO BE FULLY ANCHORED IN THE CORE WALLS. ”

The maximum thickness of walls in the cores is a substantial 1.2 m at the lower levels. Columns were designed as concrete-filled steel tubes (CFT) of a 1.5 m maximum diameter at lower floors and a steel tube thickness of 90 mm. The column diameter reduces towards the top of the building. In addition to these vertical elements, there are three

service levels with outrigger walls – spanning between columns – and cores to limit the horizontal movement of the structure.

PT SYSTEMS

A post-tensioned band beam option was chosen for the typical levels, thus providing the most economic and minimum depth option for the client – with the majority of beams spanning a significant 16.8 m in one direction between the main core and the CFT columns, from where the bands cantilever six meters to the slab edge. The band beam size for the typical levels is 3,000 mm wide and 550 mm deep. The 200 mm deep reinforced concrete slabs which span between these band beams were designed and detailed by Structural Systems. Service levels were designed as flat slabs 450 mm to 500 mm deep – the thickness depending on the loading and locations – and the consultant required additional pre-compression to be provided below and above every outrigger wall to improve the lateral stability of the structure.

DESIGN CHALLENGES

Special steel connection details between the post-tensioned banded beams and every CFT column required considerable additional reinforcement to meet the engineer's requirements. This detail did not give us a lot of space to run the three ducts with five 15.2 mm strands on either side of the columns. Another of the numerous challenges was to cater for the extreme cantilevers which were typically six meters, but extended in certain locations to up to 10.8 m in length. We were responsible for ensuring that perimeter deflections were controlled and that the very sensitive 4.4 m tall glass-faced panels would not be damaged by floor slab deflection. Numerous meetings were held between the designer, contractor and ourselves to make sure that the design and details were integrated and, most importantly, that the details shown on the drawings were actually buildable on site.

INSTALLATION CHALLENGES

Probably the biggest challenge, from an on-site point-of-view, was to satisfy the engineer's requirement for a minimum of 50% of the tendons to be fully anchored in the core walls. This was achieved in the lower floors by installing dead end 'onions' inside the walls, but the heavily congested wall reinforcement made this a difficult task. As works progressed to the upper floors, the main contractor wanted to construct all cores in advance of the floors. This then



necessitated the installation of live, rather than dead, anchorages with 'dummy tendons' in the walls. Stressing of these tendons had to be done from inside the core. With access to the live ends available only from the top of the core walls, our site team had to go down two levels inside the core to perform stressing operations. With outside temperatures often exceeding 45 °C, limited ventilation inside the core walls and the extreme humidity encountered, we ultimately built this icon with sweat and determination! ●

.....
TEAM & TECHNOLOGY

OWNER Abu Dhabi National Oil Company
MAIN CONTRACTOR Six Construct Co. Ltd
TECHNOLOGY BBR CONA flat
BBR NETWORK MEMBER Structural Systems Middle East LLC (United Arab Emirates)



BUILDINGS

Fostering creativity

SCHOOL OF THE ARTS, SINGAPORE (SOTA)

Situated in The Arts & Heritage district of Singapore, the School of the Arts is the first independent pre-tertiary Arts school to nurture youths who are passionate about and committed to the Arts in a multi-cultural society. It also aims to nurture the next generation of artists and creative professionals, reports Kew Kim Mei of **BBR Construction Systems** in Singapore.

The building, which is a showcase for eco-friendliness and flexibility, consists of two parts – the Backdrop and Blank Canvas. The Backdrop is a podium containing a concert hall, drama theatre, black box theatre and several small performing spaces. Meanwhile, Blank Canvas provides the school area where the curriculum fosters greater clarity of insight, critical evaluation and creativity. Post-tensioning has been used to provide generously proportioned classrooms with performing space by increasing the headroom and allows longer spans between columns. In addition, the classrooms are designed in nine meter square modules with movable end walls which allow for future changes in use.

This project is a composite structure, using both steel and concrete. The columns are made of steel and encased in concrete for fire protection. During construction, there were difficulties in connecting the columns and beams with PT tendons and we resolved

this by adopting an unconventional method. Firstly, reinforcement bars were welded to the steel column. Part of the beam was a 'box-out' at the stressing anchors. The reinforcement bars of the beam were bent up temporarily to allow access for the stressing jacks. After the tendons had been stressed, the bars were bent back into position and the box-out was concreted. The formwork was removed only after the concrete had gained sufficient strength. ●

.....
TEAM & TECHNOLOGY

OWNER Ministry of Information, Communications and the Arts
MAIN CONTRACTOR Tiong Aik Construction Pte Ltd
STRUCTURAL CONSULTANT Worley Parsons Ltd
TECHNOLOGY BBR CONA flat
 BBR CONA internal
BBR NETWORK MEMBER
 BBR Construction Systems Pte Ltd (Singapore)

OFFICE BUILDINGS,
WARSAW & SZCZECIN,
POLAND



Driving quality and economy

With the support of its dedicated post-tensioned slab technology department, managed by Bartosz Lukijaniuk, **BBR Polska** has been rather busy lately with two prestigious office projects – one in Warsaw, the other in Szczecin. Their work proves that quality and economy can indeed go hand-in-hand.

1 BUSINESS GARDEN WARSAW

In Warsaw, we were commissioned to provide PT services for the construction of two office buildings for the Business Garden Warsaw development near the international airport – the developer is planning to extend this office complex later with another five buildings.

The first building (B1) has a total service area of around 13,000 m² while the second building (B2) is around 17,000 m² – both blocks are seven storeys high and have two underground parking levels for 260 and 265 cars respectively. All slabs are executed as PT slabs – in each building we executed nine post-tensioned slabs which amounted to a total of 51,500 m² across the two buildings. Building B1 is very irregular shape with levels 0 and +1 in one block, above which it divides into three towers. Tower A is three storeys high with floors typically of 450 m², Tower B is six storeys high with floors typically of 640 m² and in the six storey hotel tower typical floors are 1200 m², divided into two pours – only a few slabs are similar. Meanwhile, Building B2 is a more regular shape of three linked triangles and all slabs above ground level are similar. PT slab solutions had already been chosen at the preliminary design stage, however, the developer allowed some alternatives. For example, evaluation was made of using prefabricated concrete elements, however, in

the end, our PT solution turned out to be around 15% cheaper.

Building B1 will house a hotel, some public services, restaurants and office area and Building B2 will contain offices.

The complexity of the building shape makes construction equally complex. Slab spans vary from seven to 11.5 m, often with a five meter cantilever – the spans are very irregular. In building B1, slab thickness varies from 200 mm in the underground parking to 350 mm in the cantilever section of two towers. The RC rate is between 13 and 17 kg/m². In building B2 the typical floor has shape of three triangles joined together. Typical floors are 2600 m², with slab thicknesses of 250 mm and 300 mm – here the RC rate varies between 15 kg/m² in the underground parking and 10 kg/m² for a typical floor – the latter is divided into three pours linked with expansion joints. All slabs are designed with C30/37 concrete.

We used BBR VT CONA CMM 0106 tendons made of 15.7 mm nominal diameter strands with a 150 mm² cross-section and tensile strength of 1860 MPa. In total, we used 260 t of prestressing steel.

2 BRAMA PORTOWA I & II, SZCZECIN

Meanwhile, in Szczecin, our site manager, Bartosz Chmielewski, has been managing the Brama Portowa I and II development which

comprises two buildings located in the very heart of Szczecin city centre. Both buildings are being performed with PT slabs using the unbonded BBR VT CONA CMM 0106 system and in total, we used 50 t of prestressing steel.

The first structure is known as 'Grzybek' (mushroom) and comprises 4,000 m² of office space, 580 m² of service area and a single-floor underground car park. In the above ground levels, we are using 200 mm thick post-tensioned slabs – each slab covers 900 m².

The second building – named 'Poczta' (post-office) – consists of 6,800 m² of office space and a 1,400 m² service area, including a car park. The slabs for this building were constructed by making two pours for each of the seven PT floors – each pour consisted of around 650 m² of concrete.

The buildings were originally designed with traditional reinforced cast in-situ concrete. Slabs are supported by concrete columns spaced about every eight meters, cores with staircases and lifts, plus external walls. In the tender stage design, slabs were 250 mm thick and RC consumption was about 30 kg/m².

We proposed and delivered a post-tensioned slab solution which allowed the slab thickness to be reduced to 200 mm and RC rate to 12.5 kg/m². With our PT solution, the general contractor saved around €5 per square meter on slab construction.

BBR Polska's scope of work on both the Warsaw and Szczecin projects covered delivery of alternative design for PT slabs, delivery, installation and stressing of tendons, plus delivery and installation of anchorage zone reinforcement.

TEAM & TECHNOLOGY

CLIENT SwedeCenter

MAIN CONTRACTOR Hochtief Polska

DESIGNER Arcade Polska
PT slabs by SDS Sp. z o.o.

TECHNOLOGY
BBR VT CONA CMM monostrand

BBR NETWORK MEMBER
BBR Polska Sp. z o.o. (Poland)



PLAZA 33, PETALING JAYA, MALAYSIA

Taking the load

A two stage casting with three stage stressing, was designed as an engineering solution to handle the heavy casting weight of a transfer beam – thereby preventing overloading of floors below – while reducing propping costs. Mohd Yusri of **BBR Construction Systems Malaysia**, describes the project.

Plaza 33 is a Grade-A office building located in Section 13, Petaling Jaya and consists of two office towers of 16 and 25 storeys and a podium. The beam has a single span of 24.3 m supporting two columns carrying loads from 20 storeys. As the columns are spaced at eight meters, harped tendons with horizontal flat profiles between the columns are designed to provide an uplifting force to balance the gravity loads. The beam was first cast to a height of 1.7 m, with four fully-embedded BBR CONA 1905 tendons. The props and backprops were designed to carry only 1.7 m of concrete, rather than the full height. Without the PT solution, the construction loads transferred down to ground level would have exceeded the capacity of the constructed floors. Upon achieving a transfer strength of 30 N/mm², the tendons were stressed to 75% UTS. The props and the 1.7 m deep beam, could now support the casting load from the second pour for the remaining 3.3 m height. After second stage stressing of another eight CONA 1905 tendons, the props were removed. Stage 3 stressing was carried out for the remaining six CONA 1905 tendons after construction of Level 7. The tendons could only be stressed from one side and to avoid obstruction to column rebar, the 18 anchorages were placed in five layers within the narrow 1.5 m wide beam. The final precompression applied to the beam was 3.5 MPa. Horizontal shear resistance between the two cast concrete layers was provided by vertical shear links. To ensure that the two cast layers acted monolithically during the second and third stage stressing, the prestress tendons were profiled to angle sharply across the horizontal construction joint by taking advantage of the harped tendon profiles. By employing prestressing technology and incorporating our construction methodology in the prestressed beam design, the client has reaped the key rewards of savings in props, backprops costs – and prevented overloading the constructed floors below. ●

TEAM & TECHNOLOGY

OWNER Plaza 33 Sdn Bhd
MAIN CONTRACTOR Siab (M) Sdn Bhd
BUILDING DESIGNER/CONTRACTOR
 BBR Construction Systems (M) Sdn Bhd
TECHNOLOGY BBR CONA internal
BBR NETWORK MEMBER
 BBR Construction Systems (M) Sdn Bhd (Malaysia)

ASIA SQUARE, MARINA BAY, SINGAPORE

Record cycles for high rise



A twin tower mixed-use development – Asia Square – is rising in Singapore's Marina Bay Business and Financial Centre. It comprises two million square feet of premium office space, 60,000 ft² of retail space, a 305-room five star luxury hotel and a 100,000 ft² fully sheltered and landscaped plaza. Lim Suan Suan and Yeo Swee Choo of **BBR Construction Systems**, the BBR Network Member in Singapore, outline their work in supplying, installing and stressing works for the post-tensioning required in the construction of the two towers.

Each tower provides a highly efficient, column-free floor plate consisting of post-tensioned beams and RC slabs, supported by external columns and core walls. Deep haunches were provided where there are moment connections to the columns. Clashes between the tendons and reinforcements were studied and resolved long before construction commenced.

We are proud to be able to say that, using a climbing formwork system and working a 24-hour shift pattern, we are achieving a 7-day cycle for each pour – currently the local record for the fastest pour cycle. Post-tensioning systems not only cut down the cost of construction and self-weight of the building, overall it has also saved lots of time! ●

TEAM & TECHNOLOGY

OWNER MGPA
MAIN CONTRACTOR Hyundai Engineering & Construction
STRUCTURAL CONSULTANT Meinhardt (S) Pte Ltd
TECHNOLOGY BBR CONA flat
 Climbing formwork
BBR NETWORK MEMBER BBR Construction Systems Pte Ltd (Singapore)



EXCEL, LONDON, UK

International showcase

ExCeL London represents a £150 million investment in the exhibitions industry. The recent second phase of development has pushed ExCeL London to around 100,000 m² of flexible flat floor exhibition and conference space. Richard Gaskill of **Structural Systems** – the BBR Network Member in the UK – describes this huge development.

ExCeL London is an international events and conference centre, located in the Royal Docks, which hosts a variety of events from high profile exhibitions and conferences to international association meetings, award ceremonies and sporting events. In 2012, the venue will host seven Olympic and five Paralympic events.

This second phase of development was a further massive investment focused on providing superior world class event facilities in London, as well giving added support to the capital's ambition to host an ever increasing number of high profile domestic and international shows. This international events venue – now valued at around £300 million in total – is the largest and most versatile space in London.

In addition to the vast halls totaling 65,000 m², there are five on-site hotels catering for budget and luxury clients, which provide 1,500 rooms, plus over 90 fully serviced apartments, 45 meeting rooms and 3,700 on-site parking spaces. We teamed up with concrete construction specialist PC. Harrington Contractors, who had commenced a 47-week contract which included the groundworks, drainage, pile caps and structural concrete for construction of the new North Hall and lorry way, as well as the South Hall, lorry way and ramp. The scheme was designed by main contractor Sir Robert McAlpine's in house design team who indicated a PT density of 30 kg/m³ for North and South Lorry ways and 25 kg/m³ for both the North and South



Hall. As part of their specification, they had indicated that all strands should be 15.7 mm seven wire super-grade with a minimum breaking load of 279 kN. Concrete strength was specified as a minimum of 40 MPa and the design accommodated a one hour fire rating requirement. Each hall was separated into pours – with the North Hall having 10 and the South Hall 12. The lorry ways were split into a further three and four pours respectively. The slab was nominally 240 mm thick, with 475 mm deep beams – which covered approximately 65% of the scheme – at centers ranging from 7.8 m to 10.5 m and a 600 mm deep beam at one end. Pours 3, 6, 9 and 12 were 270 mm thick on the North Hall and 300 mm thick on the South Hall, with all of these areas being adjacent to the lorry ways. The area of the halls and lorry ways together totaled 27,689 m². During our 16 weeks on site, we installed our CONA flat 206, 306 and 406 bonded post-tensioning systems. Internal pans, where



.....
TEAM & TECHNOLOGY

OWNER ExCeL London
MAIN CONTRACTOR Sir Robert McAlpine
TECHNOLOGY BBR CONA flat
BBR NETWORK MEMBER
Structural Systems (UK) Ltd
.....



“ THE SLAB WAS NOMINALLY 240 MM THICK, WITH 475 MM DEEP BEAMS – WHICH COVERED APPROXIMATELY 65% OF THE SCHEME ,”

required, were installed along each side adjacent to the lorry way to allow post-tensioning to take place.

The project has provided much-needed additional exhibition and conference space, as well as a 5,000 seat semi-permanent auditorium at this venue. One of the more unusual features of the construction process was that – after completion of the column pile caps – the main contractor erected the steel frame and roof, while the suspended post-tensioned floor slabs for the exhibition halls and lorry access way were constructed afterwards. Among the challenges during our construction period was the need to maintain access for maritime exhibits during the London International Boat Show! ●

Local insight: Docklands



The ExCeL exhibition centre sits close to the Isle of Dogs, in the heart of an area defined by its seafaring and trading past. Although hard to imagine now, London Docklands was once a hive of activity, fuelled by the arrival and departure of ships transporting goods from all over the world. The docks here grew up primarily in the early 1800s, with later additions in 1880 and 1921. However, by the 1970s, commercial shipping consisted mainly of container ships which required deep water berths. Thus, the old docks progressively fell into disuse until the vision of regeneration was born in the 1980s. Now, the shining Canary Wharf development – during which Britain’s tallest building was constructed – stands as a beacon for regeneration and has established a second major financial centre in London.



BIW HOTEL, KINGDOM OF BAHRAIN

Fast and five star

Bahrain Investment Wharf (BIW) is a joint venture between the Bahrain Government and Al Khaleej Development Company (Tameer). Roland Zachar, Design Manager for BBR Network Member **NASA Structural Systems LLC**, reports how they have helped to develop the wharf by post-tensioning the floor slabs of the new five star BIW Hotel.

The master plan of the US\$2 billion BIW project is divided into four major sectors – an industrial park, business park, residential and service areas – totaling 1.25 million square meters of rentable area. BIW is strategically located – near to Bahrain’s International Airport, the Seaport, the highway leading to the causeway linking Bahrain and Saudi Arabia, as well as the newly proposed causeway between Bahrain and Qatar – for ease of import and export of goods.

Given the significant overall length of the project, each level of the hotel was divided into three pours by the inclusion of expansion joints. All 13 levels above the ground were designed as post-tensioned flat slabs using the BBR CONA flat system with 305 and 505 anchorage sizes. The lower, more heavily loaded levels, consisted of 220 mm deep post-tensioned flat slabs, whereas slab depths of only 200 mm were required for the upper levels.

The majority of projects in the Middle East over recent years have been carried out at a much faster pace than is typically experienced in Europe. The period between signing the contract, finalizing the design, mobilizing on site and pouring the concrete can be limited to a matter of days – and this BIW job was a prime example. A price was agreed with the main contractor on Thursday, the letter of intent received on the following Saturday – and the first pour at ground floor level was cast within a 10 day period.

The whole project progressed at a similar pace – with all 21,000 m² of post-tensioned slabs designed, installed, poured and stressed in less than five months from us receiving the go-ahead on the project. In recognition of our excellent service during the works, the contractor awarded us the design and installation of post-tensioned slab for the associated multi-functional hall. ●

TEAM & TECHNOLOGY

OWNER Bahrain Investment Wharf

MAIN CONTRACTOR Al Namal Construction Co.

TECHNOLOGY BBR CONA flat

BBR NETWORK MEMBER

NASA Structural Systems LLC (United Arab Emirates)



UNIVERSITY BUILDINGS IN THE UK AND AUSTRALIA

Degrees of difference



Two different university buildings, two different countries – and two very different challenges. Long after they had graduated, engineers from the BBR Network recently found themselves back on the campus. In both cases, they provided technically excellent solutions in some very unusual circumstances – each one leading edge and perhaps providing food-for-thought for any engineering undergraduates who happened to pass by the construction sites!

1 MAKING WAVES

The £19 million new Marine Building at Plymouth University now accommodates state-of-the-art research facilities, including the most technically advanced wave tank and testing facilities in Europe. The two giant ocean and coastal wave tanks are – at 48 m by 16 m – nearly the size of an Olympic swimming pool, and will contain 225,000 liters of water; all suspended from the floor above. During the project, BBR Network Member, **Structural Systems UK** provided post-tensioning expertise for the construction of some of the largest concrete beams ever produced in the UK. The structural system chosen was precast post-tensioned beams spanning 16 m, with secondary spanning 100 mm deep wide-slab precast units incorporating a 125 mm structural screed. The 32 beams are 500 mm by 750 mm deep at midspan, reducing to 400 mm by 690 mm deep at 3.4 m from

each column to accommodate a crane fixed to the underside of the beams. Each beam comprised two BBR VT CONA CMI 706 bonded multistrand anchors with single end stressing. As deflection remained an issue after initial stressing, a full-scale FE vibration analysis confirmed a response factor of 3, this was accepted by the building client. Transporting the 16.3 m beams to site was a logistical feat in itself and required a specialized trailer and a special high load capacity crane, imported from Asia, on site to lift the beams into position. Beam design also had to consider the different permutations and stresses involved in the lifting process. Supporting the beams on a relatively small column width meant that the traditional recess provided for the multi-strand anchor interfered with the anchorage length for the support reinforcement. Placing the anchor bearing plate on the external face of the

“ DURING THE PROJECT, BBR NETWORK MEMBER, STRUCTURAL SYSTEMS UK PROVIDED POST-TENSIONING EXPERTISE FOR THE CONSTRUCTION OF SOME OF THE LARGEST CONCRETE BEAMS EVER PRODUCED IN THE UK ”



beam removed the recess requirement, but left the anchor exposed. The architect accepted the detail once a plastic end cap was sourced to minimize the impact of the protrusion on the building space. We also undertook the in-situ prestressing of two 800 mm wide by 1,000 mm deep beams providing support for one of the suspended coastal tanks. Use of two CONA CMI 706 tendons for each beam eliminated three layers of congested bottom reinforcement and provided a crack-free structure, increasing the durability and design life of the tank.

incorporated approximately 120 t of 15.2 mm diameter slab and beam post-tensioning, stressed to 212 KN per strand. In addition to this, seven strand vertical multistrand PT tendons were also installed at the extreme corners of each of the service cores to counteract the large lateral loads generated within the buildings.

The large double-height clear span lecture theater, presented our design team with a series of unique challenges. To achieve the large open space, four complex transfer beams were required at level 3. These were



2 VITAL DEGREES

Michael Losinski, Design Manager for Australian BBR Network Member, **Structural Systems Ltd**, reports on the engineering challenges and development of the construction techniques that led to the successful completion of Swinburne University's iconic Advanced Technology Centre in Melbourne.

We provided the main contractor with a complete structure package that included post-tensioning design and installation, formwork, steel fixing and concrete placement. Understandably, Swinburne University was keen to make use of their new facility and all parties were constrained by an extremely tight design and construction program. The horizontal structure

formed with a maximum structural depth of 3.45 m and each was required to span approximately 20 m to carry all eight of the levels above. The BBR VT CONA CMI multistrand system was utilized within these beams, with each beam containing a total of 93 strands each – or three 31 strand tendons. Stage stressing of both monostrand and multistrand tendons within the transfer deck was imperative to ensure adequate stress and deflection criteria were met throughout all construction stages. Monitoring of beam edges was conducted by daily surveys to ensure that shrinkage of the transfer beams was maintained within the calculated limits. Construction requirements and site logistics required that the large transfer beams were poured as one single element with no

horizontal construction joints. This ultimately raised concerns regarding the heat of hydration generated within the deep beams. Of major concern were the excessive differential temperatures that could occur through the large depth, potentially generating structural voids and failure planes within the beams. To combat this issue, specific concrete design mix, formwork and curing procedures were implemented to monitor and minimize the calculated temperatures expected. Along with our concrete suppliers, we undertook extensive analysis of the concrete mix, and thermocouplers were installed within all the transfer beams to monitor the heat generated. The delivery temperature of the concrete was imperative in achieving acceptable temperature criteria and, hence, we explored – and later used – cooled aggregates. This additional measure ensured that the maximum delivered concrete temperature did not exceed 10 °C. The formwork remained in place, acting as an insulator until ambient temperatures in the beams had been achieved. Curing of the slab surface was vital to ensuring that surface temperatures were kept at a relatively consistent rate, compared to that within the beams. Results from the thermocouplers indicated the maximum core concrete temperature was approximately 52 °C and the differential temperature between core of beam and external face was minimized to less than 20 °C. The use of multiple post-tensioned systems, techniques and design considerations throughout this structure, ensured that construction continuity could be maintained. Casting transfer beams in one single pour meant that formwork could be stripped at an early stage allowing for all contractors to begin works earlier; thus meeting the tight deadlines set by the client.

TEAMS & TECHNOLOGIES

1 PLYMOUTH UNIVERSITY

OWNER University of Plymouth

MAIN CONTRACTOR Leadbitter Group

TECHNOLOGY BBR VT CONA CMI internal

BBR NETWORK MEMBER

Structural Systems (UK) Ltd

2 SWINBURNE UNIVERSITY

OWNER Swinburne University of Technology

MAIN CONTRACTOR Kane Constructions

ARCHITECT H20 Architects

STRUCTURAL CONSULTANT Watermans

PT DESIGNER Structural Systems Limited

TECHNOLOGY BBR CONA flat

BBR VT CONA CMI internal

BBR NETWORK MEMBER

Structural Systems Limited (Australia)

Unleashing creativity

One of the many projects connected with the 2012 UEFA European Football Championship to be held in Poland and Ukraine is the construction of railway junction near the Euro 2012 Football Stadium in Wroclaw. Early collaboration at the design stage has enabled the optimal use of the BBR VT CONA CMX system in almost every element of design. Pawel Surman, Site Manager for **BBR Polska**, describes the versatility of the system and how it can be used anywhere.



RAILWAY VIADUCT, WROCLAW, POLAND

The superstructure of the viaduct comprises two tram tracks with platforms and bicycle tracks. Under the main structure are two railway lines, a railway station and two carriageways. Also integrated into the structure are two lift shafts, stairs allowing communication between levels and a wide ramp leading in the direction of the football stadium. All elements – apart from the concrete superstructure and piers – were made using architectural concrete techniques.

The main structure was formed from C50/60 concrete and has an irregular shape where the



maximum width of the viaduct of 29.3 m and minimum is 18.7 m. The main structure is supported on seven supports, each of which is located at a different angle relative to the axis of the structure (39-76 °), which causes a large variation in span lengths which range from 12.2 m to 36.7 m. Beams have different total lengths – from 104.9 m to 163. The structure is post-tensioned with CONA CMI 1906 and 2206 tendons. The superstructure was concreted on scaffolding in two stages which resulted in the use of inaccessible fixed anchorages, K-couplers and continuous tendons running over the whole length of the viaduct.

The roof is supported by among other things, three skewers from the vertical walls made of C35/45 concrete. The largest wall was post-tensioned using CONA CMI 1906 tendons and concreted in two stages. This wall was designed as a single-span structure where the tendons are located horizontally in the lower part.

The roof is a monolithic prestressed concrete slab which has a four-sided irregular shape and was made from C50/60 concrete. The slab is fixed to three walls and additionally supported on concrete-filled steel columns deviated from the vertical.

The roof has a variable thickness from 50 cm for the walls, to 24 cm at the end of the 12.75 m long cantilever. The roof is post-tensioned, in both longitudinal and transverse directions, with 50 CONA CMM 106 and 197 CONA CMM 406 tendons made up of four strands. Each tendon has a different length from two to 92 m!

We used a total of 64.6 t of bonded stressing steel for the superstructure and 2.9 t for the wall, plus a further 17.4 t of unbonded stressing steel for the roof. All tendons had cross-sections of 150 mm² and a tensile capacity of 279 kN.

This project admirably illustrates the wide variety of applications the BBR VT CONA CMX system offers and how early collaboration, between the designer and ourselves, can result in a very interesting and lightweight structure. The use of post-tensioning has allowed the construction of a slender – and somehow transparent – structure. It can only serve to enhance our environment when public buildings gain attractive and more expressive forms at the very frontier of architecture and sculpture. While projects like this play an important role in our portfolio, it is the work of designers that really shows how creativity is unleashed by the unlimited possibilities, for making any form of structure, offered by the use of BBR technology. ●

TEAM & TECHNOLOGY

OWNER Gmina Wroclaw

MAIN CONTRACTOR Filar Sp. z o.o.

DESIGNER Arcadis Sp. z o.o. & Ozone & ZNTiW Inmost-Projekt

TECHNOLOGY BBR VT CONA CMI internal BBR VT CONA CMM monostrand

BBR NETWORK MEMBER
BBR Polska Sp. z o.o. (Poland)

World consumption of Liquefied Natural Gas (LNG) continues to be strong – even in 2009, during the global economic slowdown, world LNG trade rose around 6.5%. Here, we review the market and award-winning approach of the BBR Network in delivering the specialized containment facilities required by this sector. →

BBR TECHNOLOGY MEETS
LNG DEMANDS

Consuming passion for LNG

LNG market outlook



The problems at Fukushima, following the earthquake in Japan, have prompted a review of nuclear policies in many countries and the outcome of these may ultimately benefit the LNG market. Supply of LNG is also increasing, with new fields coming on-line – and there are many potential new LNG importers too, including prospective customers in Central and Eastern Asia and Eastern Europe.

Many agencies have produced reports on future trends within the LNG sector and points raised which may be relevant to the BBR Network are summarized below:

- ▶ LNG import capacity is predicted to grow by 105% by 2015.
- ▶ By 2015, a further 16 importing markets are set to enter the global LNG trade.
- ▶ Over the next three years, there will be a 400-fold increase in LNG tankers sailing around the world.
- ▶ Although still in its growth stage, floating LNG export markets are expected to play a major role by 2015.
- ▶ More than US\$140 billion will be invested in construction of new LNG export plants between 2010 and 2015.

As new natural gas reserves are developed and progressively come on-line, appropriate receiving facilities are needed in markets importing LNG. Significant foresight and organization is required in this process – typically, it takes some 5-10 years for the planning and construction of import and export terminals.

“ THE PROJECT IS OF THE HIGHEST STANDARD AND REFLECTS ALL THAT IS BEST IN INNOVATIVE USE OF CONCRETE IN CIVIL ENGINEERING ”

Concrete Society Awards 2008 Judging Panel – South Hook LNG Tanks, Wales

NORWEGIAN LNG PLANT

At the new LNG processing and storage facility in Stavanger – created for energy provider Lyse Gass – Norwegian BBR Network Member **KB Spenneteknikk** installed the post-tensioning for a new 20,000 m³ tank, using latest European approved BBRVT CONA CMI internal horizontal and vertical loop tendons.



WORLD'S LARGEST LNG TANK

Completed in 2006, the 188,000 m³ capacity LNG tank at Darwin, Australia was one of the largest above-ground tanks in the world at the time. Some 47 m high and approximately 94 m in diameter; the tank comprises a 550 mm thick outer concrete wall and nickel alloy steel lining. Australian BBR Network Member **Structural Systems** was engaged to install, stress and grout approximately 570 t of post-tensioning tendons.



International portfolio

In the past decade, the BBR Network has applied its expertise to the construction of many massive LNG storage structures – and some projects have even attracted prestigious awards. Design and construction techniques for cryogenic containment were featured in *CONNAECT 2007*, now we update the BBR Network's LNG portfolio with some international highlights.

BBR technology and know-how have been applied innovatively to LNG projects all around the globe. Consequently, the wealth of knowledge within the BBR Network, specifically relating to the successful delivery of LNG construction, is immense and is routinely applied as 'best practice' for further projects.



WORLD'S FIRST OFFSHORE LNG TERMINAL

The Isola di Porto Levante offshore LNG Terminal – a Floating Storage and Regasification Unit – is a gravity-based structure (GBS) and was constructed in a large dry dock facility in southern Spain.

The project attracted a special mention in the 2010 *fib* Awards for Outstanding Concrete Structures and the judges praised the project for the way in which congested areas were handled and for the high quality of workmanship.

BBR PTE developed the post-tensioning works in association with two other companies. The GBS was taken by tugboat to its final destination – 17 km off the coast of Italy.



TANKING UP IN SPAIN

Over the past seven years, **BBR PTE** has constructed four LNG tanks in Barcelona and one in Cartagena as part of Enagas installations and are now constructing a further two tanks for them in Gijon (see pages 52 & 53).



AWARD-WINNING LNG CONSTRUCTION

The UK's largest civils project in 2008 was declared the winner in the civil engineering category of the Concrete Society Awards. The team from BBR Network Member **Structural Systems (UK)** constructed five 92 m diameter post-tensioned LNG storage tanks at the South Hook site in Pembroke Dock in South Wales.



LNG TANKS, GIJON, ASTURIAS, SPAIN

LNG to enhance regional economic growth

David Olivares Latorre of **BBR PTE** in Spain provides an insight into the BBR Network's most recent LNG project where two tanks have been constructed for Enagas at the Port of Gijon.

The Port of Gijon, on the Cantabrian Sea sustains many freight and passenger activities and has the facilities to handle a variety of commercial requirements. In the general rankings, Gijon comes in sixth place – but, in operational terms, it is the fourth largest port in Spain. This project gives the Principality of Asturias a reception terminal for storage and regasification of 300,000 m³ of LNG which will arrive at Gijon by sea. This development offers many advantages – it supports growth of the new energy market in Spain, places Asturias in a good commercial position and Gijon will become an exporting port with a strong international presence.

DESIGN CONSIDERATIONS

As with other tanks built in Spain, security and resistance are the primary design considerations in constructing these new tanks which are designed to withstand earthquakes and strong winds. Construction needs to achieve a very high quality – using only the best construction materials and technologies. The two tanks – built simultaneously – are cylinder-shaped and have an 80 m external diameter and are over 40 m high. In each tank, we used more than 600,000 kg of post-tensioning steel, divided into vertical and horizontal tendons.

PRESTRESSING TECHNOLOGY

The prestressing technology selected for this project was the BBR VT CONA CMI system for cryogenic applications which was used as follows:

- ▶ four foundation slab rings – 48 CONA CMI 2406 anchorages with 131 m long tendons;
- ▶ cylinder horizontal wall – 292 CONA CMI 1506 anchorages with 130 m long tendons;
- ▶ cylinder vertical wall – 136 loops, each 85 m long, plus 272 CONA CMI 1906 anchorages.

The foundation slab rings and horizontal tendons were formed with galvanized duct. While the vertical loops also have an inferior curve made of galvanized duct, the rest of the vertical straight design was constructed with jointed eight meter sections of 104 mm stiff duct – connected at the expanded end of the tube, thus allowing a rigid joint to be formed between sections.

“ SECURITY AND RESISTANCE ARE THE PRIMARY DESIGN CONSIDERATIONS IN CONSTRUCTING THESE NEW TANKS WHICH ARE DESIGNED TO WITHSTAND EARTHQUAKES AND STRONG WINDS. ”

PUSHING & STRESSING

To push the horizontal cables, we hung the strand pushing machine from a crane and the operators worked from an elevator. The pushing machine was tied to the tank to avoid any unwanted vibration or movements during the operation. Meanwhile, the vertical cable loops were pushed using a flexible duct situated between the M1906 anchorage and the pushing machine.

Foundation slab rings were stressed before tank construction and remaining tendons were stressed during construction to accommodate the forces acting on the structure. The established stressing sequence began with some of the horizontal tendons and the next stage was to stress the first half of the vertical loops. Next, half of the horizontal tendons were stressed, followed by the second half of the vertical tendons. Finally, the lowest horizontal cables were stressed beside the access doors.

GROUTING & BLEEDING

The chosen cement grout was a thixotropic grout made with Portland cement I-42.5, thixotropic admixture and water ($w/c=0.44$). In addition to the standard tests for grout, we made a battery of inclined tube tests and wick-induced tests to demonstrate the suitability of the grout, obtaining excellent results in terms of bleeding, change of volume and workability to latest European EN standards. The method specifically designed for vertical tendons is the wringing method which consists of creating a forced bleeding of the grout by applying pressure, thus forcing the water out of the tendon through the strands at the upper anchor head. The result of this is the complete elimination of any possible exudation of water at the top of the tendons.

TEAM & TECHNOLOGY

- OWNER** Enagas S.A.
- MAIN CONTRACTOR** FCC INDUSTRIAL
- DESIGNER** FCC INDUSTRIAL – Dirección Técnica + Carlos Fernández Casado
- TECHNOLOGY** BBR.VT CONA CMI internal
- BBR NETWORK MEMBER** BBR PTE, S.L. (Spain)

Technical insight:
BBR loop tendons

Design and construction of LNG tanks requires special post-tensioning detailing, as featured in *CONNAECT 2007*, which includes internal vertical tendons in the tank walls. Due to the limited accessibility of dead-end PT anchorages at the bottom, the installation of 180-degree loop tendons is the preferred option.

Loop tendons consist of two stressing-end anchorages, each one connecting to a straight tendon length and both interconnected by means of a 180-degree curved – or loop – tendon. Design considerations mean that both stressing-end anchorages need to be positioned quite close together, leading to a very reduced radius of curvature. A typical minimum radius of curvature in loop tendons might be up to 0.6 m – thus, considerably smaller than the minimum bending radius of a normal prestressing strand. The full PT tendon is always subjected to static loading, which prevents strand-fretting fatigue.

The high radial contact pressure of up to 900 kN/m, achieved in the curved section, demands that special care be taken when designing loop tendons:

- ▶ The curved part of the tendon is made of smooth steel pipe and is pre-bent with special techniques to avoid buckling.
- ▶ The diameter of the inner steel pipe is increased to limit contact pressure and facilitate strand installation.
- ▶ Effective sealing measures should be applied at the curved-straight duct transition to avoid the ingress of cement paste when concreting.
- ▶ The pressure exerted by the strands from the inside of the duct lead to very high radial and transverse forces in the concrete. Additional reinforcement is, therefore, installed on the inner side of the curvature to confine the concrete and properly disperse those forces through the concrete.

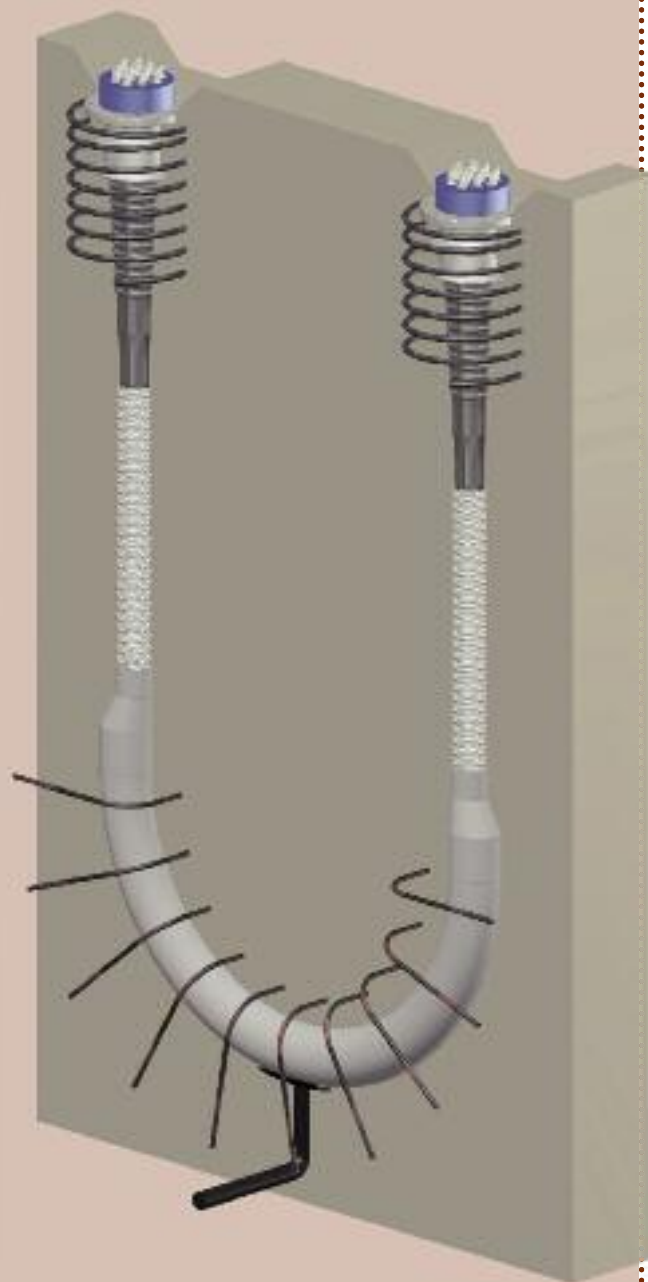



SUGAR SILO, TULLN, AUSTRIA

Expertise & easy handling

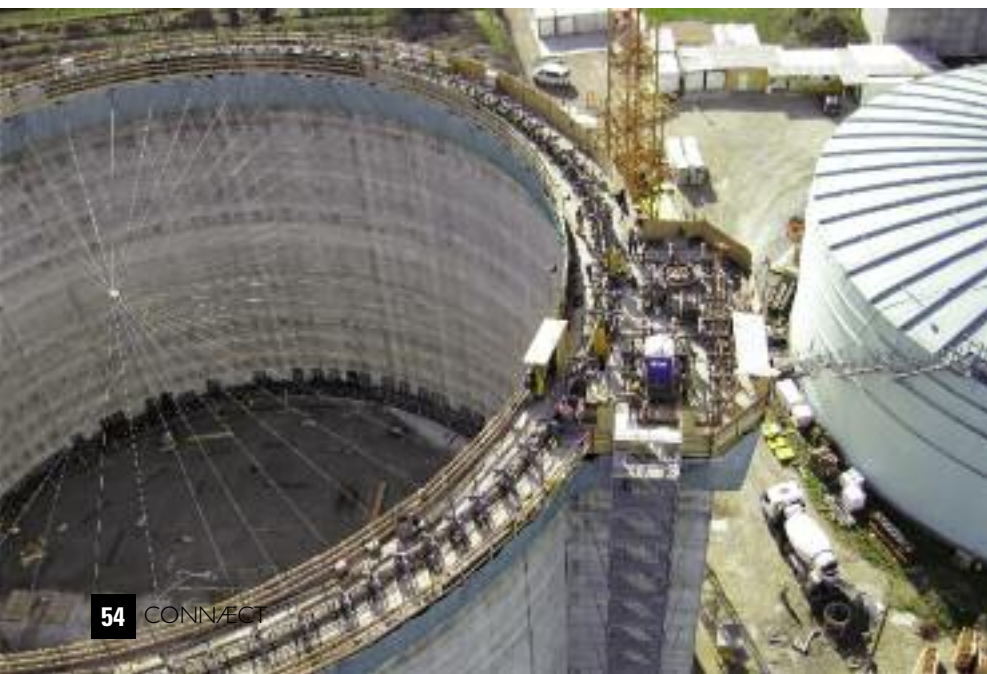

Based on excellent previous experiences and the early involvement of **Vorspann-Technik GmbH**, the BBR Network Member in Austria, the designer decided to use the **BBR VT CONA CMM system** for a new sugar silo in Tulln.

The leading sugar company in Central and Eastern Europe, AGRANA, has enlarged its storage capacity in Tulln – about 40 km west of Vienna – with a new silo. This 70,000 t crystallized sugar silo is 49 m in diameter and 52 m high – and is Europe's second largest sugar silo. Its operation will largely be automated, with sugar being handled using a 200 m-long conveyor bridge which will conform to latest hygiene and safety engineering guidelines. In addition, waste heat from the sugar production process will be used to heat and condition the silo, thus saving primary energy and associated CO₂ emissions – the latter will also be saved, as transportation by road to other storage facilities in Austria or Hungary will no longer be required.

The silo wall is a constant 40 cm thick and for the post-tensioning, we used the BBRVT CONA CMM 0406 unbonded internal system. The tendons were placed at a centre distance of 16 cm in the lower part of the silo. This meant there were six tendons with four strands for every one meter of silo wall. Therefore, we placed them in an inner and outer layer within the wall to get a real vertical distance of 33 cm between two tendons. The project was ideally suited to slipform construction and – with a plan to concrete between two and 2.5 m in 24 hours – one of the challenges for us was installing the cables quickly enough, particularly in the lower part of the silo. The slipform rig outline was enlarged by a staircase and an elevator which allowed us to have a small working platform. The design only accommodated one buttress for stressing – this meant each tendon was about 162 m long and weighed almost a ton! Tendons were produced and cut to length at our workshop near Salzburg, individually coiled up, bound and delivered on site. From the working platform, we put a single tendon into an unwinder. A pusher, similar to strand pushers used for the CONA CMI system, pushed the 0406 tendon forward from one side and a winch pulled the end of the tendon from the other side. Suspended rollers were mounted every four to five meters around the slipform rig to increase the glide of the tendon and keep it in the right position.



After pulling and pushing the tendon all around the silo, it was manually lifted out of the suspension units and fixed with wire onto the reinforcement.

With this equipment and methodology, three workers could install one 162 m tendon in about an hour – an achievement only attained because of the easy handling characteristics and installation of the CONA CMM system. Everything worked well – concreting with the slipform rig was finished within 23 days. Stressing was carried out simultaneously at both ends and generally showed slightly shorter elongation values than predicted by the designer. Overall construction time was about 11 months and the silo was finished on schedule. In October, when the sugar-beet harvest began, the new sugar silo went on-line for the first time. ●



TEAM & TECHNOLOGY

OWNER AGRANA Zucker GmbH

MAIN CONTRACTOR
STRABAG SE & Steiner Bau GmbH

DESIGNER Freund und Vogtmann Zt GmbH

TECHNOLOGY BBR VT CONA CMM
monostrand

BBR NETWORK MEMBER
Vorspann-Technik GmbH (Austria)

IN FOCUS: Sugar beet



The main focus of production in Agrana's sugar business segment is on the manufacture of sugar products from sugar beet. Sugar beet is a hardy biennial plant grown commercially for sugar production as its tuber contains a high concentration of sucrose. Sugar beets and other *Beta vulgaris* cultivars – such as beetroot and chard – share a common wild ancestor, the sea beet or *Beta vulgaris maritima*.

The European Union, the United States and Russia are the world's three largest sugar beet producers, although only the EU and Ukraine are significant exporters of sugar from beets. Beet sugar accounts for 30–35% of the world's sugar production.

Sugar beet can be grown commercially in a wide variety of temperate climates. During its first growing season, it produces a large storage root weighing 1–2 kg whose dry mass is 15–20% sucrose by weight. In commercial beet production, the root is harvested after the first growing season, as during its second season the root decreases in size due to flower and seed production. After reception at the processing plant, the beet roots are washed, mechanically sliced into thin strips called cossettes and passed to a machine called a diffuser to extract the sugar content into a water solution. This is then followed by three further processes – carbonatation, evaporation and crystallization – to produce sugar crystals.

Strengthening relationship with PT



The tally of tanks constructed by Abu Dhabi-based BBR Network Member **Structural Systems Middle East** has recently risen to 17 with the award of a contract for the post-tensioning of a further six LPG tanks in Ruwais, reports Contracts Manager Mahesh Nayak. The contract reflects a successful 12-year long working relationship in the UAE with designer and tank subcontractor, Chicago Bridge & Iron (CB&I).

Included in the contract is the construction of six identical 34.3 m internal diameter 35.63 m high LPG storage tanks – three for propane and three for butane. Concrete walls were designed as 1,000 mm thick at the bottom and tapering to 500 mm at 7.13 m from the base slab, remaining at 500 mm thick right up to the roof. CB&I had expressed the required long-term prestressing as a function of height along the wall (kN/m) and we were contracted to provide all methods, shop drawings, material, supervision and specialist equipment required for the supply, installation, stressing and grouting works.

The tanks were built with a permanent inner steel liner which was prefabricated and welded in-situ over the full height of the tank. The concrete wall was then constructed in ten equal lifts of nearly 3.5 m each – carried out over 15 day cycles – with conventional timber formwork for the outside face.

The post-tensioning anchorages and corrugated galvanized iron (GI) ducts were placed prior to concreting, while prestressing steel was installed after the wall pour. Mast climber platforms were erected to enable PT



works to proceed in an efficient manner, while tower cranes provided the necessary hoisting requirements for equipment such as stressing jacks.

Prestressing was applied to the tank wall using 52 horizontal tendons made up of either 18 or 19 strands. We used the BBR VT CONA CMI 1906 system for cryogenic applications – with 150 mm² strands with a tensile strength of 1860 MPa, delivering a Minimum Breaking Load (MBL) of 279 kN. All in all, a total of 73 km of GI ducting and 1,620 t of stressing steel was consumed. The tendons were stressed in three stages:

- ▶ Stage 1 – Ring beam tendons prior to casting of the top roof
- ▶ Stage 2 – Tendons above Temporary Construction Openings (TCOs)
- ▶ Stage 3 – Tendons passing through TCOs upon casting and closure of TCO.

Stressing was carried out when the concrete achieved a 50 MPa cube strength, as specified in our contract.

The grouting specification required that the bleeding should be determined by a wick-induced bleed test – as set out in BS EN 447:2007 – and, when tested in this way, the average of three results for bleeding should not exceed 0.3% of the initial volume of the grout. The minimum compressive strength after 28 days was to be 50 MPa. To achieve this requirement, grout trial mixes were conducted.

The project is being constructed on a fast-track basis and well ahead of its original schedule – due to excellent coordination and management by the entire project team – with the works expected to complete some way in advance of the programmed June 2012 completion date. ●

TEAM & TECHNOLOGY

OWNER Abu Dhabi Gas Industries Ltd. (GASCO)

MAIN CONTRACTOR Flour

DESIGNER/TANK SUBCONTRACTOR
Chicago Bridge & Iron

TECHNOLOGY BBR VT CONA CMI internal
BBR NETWORK MEMBER Structural Systems Middle East LLC (United Arab Emirates)

Europe's largest single pylon stay cable bridge

SAVA BRIDGE, BELGRADE, SERBIA

Featuring BBR technology in its construction, a dramatic new structure, near the confluence of the Danube and Sava rivers, has become Europe's largest single pylon stay cable bridge. The elegant Sava Bridge – the third river bridge in Belgrade – will reduce city-centre traffic congestion, as well as unleashing the Serbian capital city's northerly expansion. →

Serbia's newest landmark owes its reality to an international design competition held in 2005 by the City of Belgrade. An outstanding solution was sought for a new crossing of the Sava River – carrying three lanes in each direction, two tracks for tramways, plus pedestrian and bicycle paths on either side. The winning design was a single pylon asymmetric cable-stayed bridge, which crosses the River Sava in a single span without disturbing the river beneath. BBR Network Member **Vorspann-Technik** took up the challenge of the stay cable works, and their Site Manager, Marcel Bartikowsky, presents a review of the project and its challenges.



“ THE 376 M MAIN SPAN IS OF STEEL CONSTRUCTION SUPPORTED BY 20 PAIRS OF STAY CABLES ANCHORED AT THE PYLON AND THE SUPERSTRUCTURE. ”

The old city of Belgrade was founded on the south bank of the Danube, on an easily defensible outcrop of limestone, and spread to the south, east and west. The city now has a population approaching two million people and its continued expansion northwards has been significantly constrained by the limited capacity of the existing bridges crossing the Sava River. This created a bottleneck which increased the level of traffic congestion in central Belgrade. To reduce the city centre congestion and increase the capacity of the highway network, a third major road bridge across the Sava River was necessary. The new Sava crossing is in sight of downtown Belgrade and passes over the tip of Ada

Cigankija island. The structure, including the approaches, is the largest viaduct of the Balkan region, connecting the recently constructed business zone 'New Belgrade' in the north with the historic centre of Belgrade. The bridge forms an integral part of the inner semi-ring road and, for a couple of years, was the biggest infrastructure project in Serbia.

PROJECT OUTLINE

The overall length of the continuous bridge is 964 m which consists of a 338 m long side span, a 50 m end span and the main support system, a 576 m long asymmetric cable-stayed structure. The total width of the Sava Bridge is 45.1 m – by comparison, normal six lane



“WE COMPLETED OUR TASK WITHIN JUST A YEAR – INSTEAD OF THE ORIGINALLY PROGRAMMED 18 MONTHS.”



bridges are around 25-30 m wide. The stay structure has a 200 m high cone-shaped pylon which was constructed in concrete using self-climbing formwork. The lower section of the pylon is split into two legs which penetrate the deck between the carriageway and railway track. The two legs merge at a height of 98 m and continue as a single circular shaft – where the stay bearings are placed – up to a height of 175 m. For the pylon's tip – the uppermost 25 m – a stainless steel jacket made of sheet metal is mounted.

The 376 m main span is of steel construction supported by 20 pairs of stay cables which are anchored on the pylon and the superstructure. The extremely long and heavy main span requires the bridge to be counterbalanced by a concrete back span of 200 m – which also has 20 pairs of stays. A box section form was chosen to anchor the stay cables in the superstructure. The box section is divided into three cells – two smaller ones on the outside with the anchorages and a wider one – carrying all utility lines – in the centre. The deck slab is supported by a hollow box girder which is 14.5 m wide and 4.75 m high. The outer 15.25 m wide cantilever slabs are supported by raked brackets at four meter intervals. The deck of the main span was formed as a rectangular steel box, also divided into three cells, and weighs 8,600 t in total. The deck units were shipped to Belgrade and unloaded in the preassembly yard, close to the side span, where the sub-elements were stored and preassembled into 16 m long segments.

NO PROPS IN RIVER

A stipulation for the bridge's construction was that the main span across the River Sava should be realized without temporary propping in the river during erection. Thus, the free cantilever method – operated from one riverbank – was chosen for the erection of the 21 main span segments. The segments were loaded on a barge at the preassembly

On the record: with Holger Svensson

Dipl.-Ing., Holger Svensson, PE, CEng, is a professional engineer and former Speaker of the Executive Board of renowned consulting engineers Leonhardt, Andrä und Partner (LAP). Recently, he has published a book, *Schräggkabelbrücken – 40 Jahre Erfahrung weltweit*, about stay cable bridge design and construction, based on over four decades of extensive experience of design engineering for major international projects. He now shares a few thoughts and experiences on the Sava Bridge project and cable-stayed structures generally.

Sava is an interesting bridge – its form is that of half a normal cable-stayed bridge, so if you doubled the size you would arrive at a very large bridge indeed. It also has a couple of unique aspects. Firstly, it's the largest cable-stayed bridge with a single tower in Europe and, secondly, the sidespan – which doesn't rest on piers over the water – acts as an exact counterbalance to the main span. Originally, the bridge was designed completely in steel to reduce the weight, because the sidespans could only be supported from the shore. LAP submitted an alternative proposal for a hybrid bridge with a steel main span and concrete sidespans – the concrete acting as a counterweight for the main span. This was a really competitive alternative, as it delivered a significant cost reduction for the client over the steel option.

The whole project went extremely smoothly and came in on time and on budget. There were sliding forms for tower construction and sidespans constructed using the incremental launching method – which, incidentally, was invented by LAP in the 1960s. The 45 m sidespans were quite something – involving extremely heavy weights. The 376 m long free cantilevering

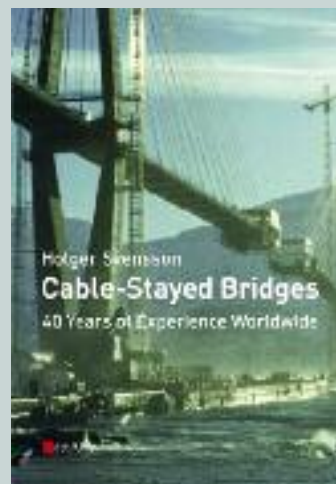

main span was fabricated in Asia, shipped to site, preassembled and installed – not a unique situation, but it went very well indeed. LAP's relationship with BBR began with the cable-stayed Schillersteg footbridge back in 1960. Fritz Leonhardt thought of using BBR tendons for their strength and stiffness and, along with colleagues, developed a system which later became BBR HiAm. This small bridge, with its parallel wire technology, was the forerunner of whole generations of major cable-stayed bridges which followed around the world.

Today, design challenges are largely around realizing longer spans. The trickiest thing with longer spans is cable dynamics. So, we use three types of countermeasures – profiled sleeves to avoid rivulet formation, dampers

and thirdly, we have the option of using cross-ties, although this is preferably to be avoided. Personally, I believe the casual observer should be able to see the flow of forces, to understand how the structure functions – many cable-stayed bridges do this well. Above all, simplicity – this is a golden rule for creating a successful cable-stayed bridge.

Schräggkabelbrücken-40 Jahre Erfahrung weltweit by Holger Svensson was published by John Wiley & Sons Limited in 2011. ISBN 3433029776, 9783433029770, 450 pages. The English version will be available in May 2012.

yard and shipped to the correct position under the bridge. A derrick crane, located at the tip of the corbel, lifted the segments which weighed up to 360 t each. After welding, the cantilevered deck was completed, the derrick was moved to the new segment and the new pair of stay cables could be installed.

STAY SPECIFICATION

For the stay cables, we used BBR HiAm CONA 5506, 7306, 8506 and 9106 anchors which were preassembled in our specialist workshop in Austria. The number of strands installed in each cable followed the requirement of the design and the sizes of the stay anchorages were chosen to →



accommodate further strands – allowing the insertion of additional strands, should this prove necessary at some future stage. The cables – each up to 375 m long – consist of compacted bundles of parallel seven-wired strands. Each individual strand is galvanized and sheathed with polyethylene coating, which is filled with grease to prevent corrosion. The outer diameter of the covering HDPE pipes varies from

200 to 280 mm, depending on the number of strands. In total, 1,280 t of high grade steel was used for the 80 cables.

ADVANCING WORKS PROGRAM

The permanent works for the bridge began on 1 April 2009 and followed a period of extensive investigation and testing of materials for use in the structures. There was a three year construction program – stay cable works were scheduled for one-and-a-half years. We planned the preparation and installation works for one set of two back span cables and two main span cables on a three weeks' cycle – including HDPE-pipe welding, strand pre-cutting, cable lifting, strand installation and stressing the cable to the required force. However, political pressures meant that the opening date for the bridge was brought forward to the end of 2011 – much earlier than originally scheduled. So, to meet the new deadline, we made some

changes to our procedure for strand installation on site. Our solution was to rewind the strands directly from the coil, without pre-cutting them. Thereby, time for installing the cables was reduced and it was possible to finish one set of stays within 12 days – including the lifting of pipes, installation and stressing. We completed our task within just a year – instead of the originally programmed 18 months.

INSTALLATION & STRESSING

First, we installed the back span cables and then the main span cables. The extremely unusual ratio between self-weight of the steel (200 KN/m) and superimposed dead load (242 KN/m) demanded that the installation should have a two stage tensioning process – an initial stressing during free





cantilevering and the final stressing in successive stages, after completion of the main span erection. Thereby, a portion of the superimposed dead load was placed on the superstructure and the geometry was checked. Then, every second stay was stressed to final force, the achieved alignment was again measured and the remainder of the superimposed dead load was placed on the deck. After this, the remaining stays were tensioned to their final force level. The stressing of the strands was completed from inside the superstructure, by monostrand jacks. After a pair of stays had

been tensioned, the cable forces achieved and uniformity were checked by carrying out lift-off tests on a number of strands. To avoid unwanted effects from temperature and solar radiation, the tests were made early in the morning and completed by parallel measurements of the geometry – pylon and deck. The required stressing force was set by the design and had a tolerance of only $\pm 2.5\%$ within the strand bundle and $\pm 3\%$ difference from each other, in one stage.

HOLD-DOWN CABLES

At the end of the back span, beside the bearings, we installed hold-down cables which were designed to prevent uplift occurring under any load combinations in the Ultimate Limit State (ULS) under factored load. The tensile stresses were kept relatively small, so that the additional stresses caused by stay bending did not exceed $0.55 \times GUTS$, in total, at the extreme deformation position. The required stressing was about 27 MN per bearing. To cope with the bending stresses, these vertical hold-down cables were of the same type as the stay cables. Three stays with 73 strands each were arranged at both of the two bearings.

COUNTERING VIBRATION

Many years ago, engineers discovered that long stay cables oscillated due to wind, rain and traffic – and, today, methods to counter these effects are well-established. So, to prevent stay cable vibrations on the new Sava Bridge, each stay cable is equipped with BBR Square Dampers at the lower end, just above the deck. Damper installation took place after the second stage stressing, because there would then be no further changes in cable geometry. The largest single pylon cable-stayed bridge in Europe now takes its place with pride – unlocking the potential of the city of Belgrade and, with its elegant lines, providing an aesthetic addition to the cityscape. ●



TEAM & TECHNOLOGY

- OWNER** City of Belgrade
- MAIN CONTRACTOR** Ogranak Porr Technobau und Umwelt AG
- DESIGNER** Leonhardt, Andrä und Partner
- TECHNOLOGY** BBR HiAm CONA stay BBR Square Damper
- BBR NETWORK MEMBER** Vorspann-Technik GmbH (Austria)





RIVER MINHO BRIDGE, LUGO, SPAIN

Suspension solution

In a €25 million scheme, the new bridge over the River Minho in the city of Lugo has taken over duties from an old Roman bridge that was no longer able to withstand the high traffic volumes. Work was completed in record time – eight months before the programmed completion date – reports Jose Luis Plaza of **BBR PTE**, the BBR Network Member in Spain.

The 195 m long bridge comprises two distinct sections. Firstly, there is a 95 m length over the River Minho which was constructed as a parabolic arch with a composite deck, supported by hangers. The second section is 100 m long and has two box girder approach viaducts constructed in two spans of 50 m and joining the central arched span at the western abutment.

The lower deck is supported by 24 75 mm diameter stay cables which are connected to the parabolic arch – terminating in a fork socket secured by pins at the upper anchorage and in a threaded socket with a spherical nut at the lower end. During construction, the arch was supported by two temporary towers situated over the steel deck.

Cable installation was performed using two cranes – one to erect the stay cables, the other to allow our technicians to align the fork socket hole with the upper arch anchorage, so that pins could be inserted. Next, a cable was introduced into the steel pipe in the steel deck girder, until the threaded lower end appeared beneath the lower anchorage.

After hanger installation, we began stressing. Four pull bars and four stressing bridges had been designed to provide symmetrical tensioning to keep the balance of the structure.

The cylindrical socket has an external and internal thread. The external one is for the permanent nut and the internal one is designed for connecting pull bars. We used four hydraulic jacks working simultaneously in pairs to carry out the procedure according to a prescribed sequence.

This was followed by several phases of checking and re-stressing previously stressed cables – to compensate for load losses – until they reached their final design stress.

After all the cables had been stressed and checked, the cables and nuts were protected against corrosion – with protection caps and grouting wax.

To dissipate cable vibrations, neoprene centering rings were installed – once the cables were structurally active and carrying the permanent loads of the structure. After all hangers had been re-stressed and grouted, the two temporary piers under the arch were removed. ●

TEAM & TECHNOLOGY

OWNER City Council of Lugo & Ministerio de Fomento

MAIN CONTRACTOR FCC Construcción

DESIGNER FCC Technical Services

TECHNOLOGY Hanger

BBR NETWORK MEMBER BBR PTE, S.L. (Spain)

Adapting to conditions



FOOTBRIDGE, WITRYLOW, POLAND

The contract for supplying and constructing the suspension system for the new footbridge in Witrylow was awarded to **BBR Polska** whose scope of work here included the installation of two main support cables, bar hangers – from which a steel deck is suspended – and wind stay cables. Adrian Basta takes up the story.



STAY CABLES

This work was carried out using two 63 mm diameter 210 m-long main cables. During installation, the cables were suspended from a temporary cable and transported to the other river bank by a system of winches and special trolleys. The main cables were then installed and fixed in the pylon deviators and, at ground level, they were anchored at the retaining blocks – the tension was based on a proper arrangement of anchor bolts in a 'bridge' anchorage. During this stage, continuous control of the main cables and all supporting elements was necessary. The 150 m distance between the pylons, as well as the river current, greatly complicated the whole operation. Including all preparatory work, the task took seven working days to complete. The suspended steel platform had been designed to use 98 20 mm diameter hangers. Bars were attached to the main cable with fork anchorages and special clamps. Bar installation took place just before the steel platform was constructed and simultaneously with suspension work. The final step was to regulate the length of the hangers to maintain the designed level of the footbridge platform. The main challenge here was the limited access to the bearing cable over the main channel of the River San.

The footbridge was fixed with 24 mm diameter wind stay cables at six points on each side of the bridge. Ten cables were used – two of which were leading along the footbridge (steel deviators were used in the platform plane) and ended on the opposite bank. Stay cable anchoring was provided by fork anchorages, which offered the option of transferring the forces to the cable – with the tension connector working as a screwdriver. The design strength of 50 kN was introduced with the help of special equipment. Minor corrections were applied to maintain the footbridge alignment. The most difficult element of the work was the installation of the main carrying cables. This required the use of tailor-made solutions and installation technology specially adapted for site-specific conditions. The whole project took seven weeks and the BBR Polska team was on site for 17 days. ●

TEAM & TECHNOLOGY

OWNER Commune Dydnia

MAIN CONTRACTOR Mota Engil Central Europe S.A.

TECHNOLOGY Suspension, stay cable
Hanger

BBR NETWORK MEMBER BBR Polska Sp. z o.o.
(Poland)

BASARAB FLYOVER BYPASS,
BUCHAREST, ROMANIA

Avant garde connections



In the centre of the city, two 80 m high pylons, part of the large infrastructure Basarab Flyover Bypass, emerge from the bustle of the city. This project has become a tremendous boost for other projects due to start in Romania over the next few years, transmitting the values of progress and innovation associated with it. Gustavo Delgado Martin from **BBR PTE**, the BBR Network Member for Romania, outlines this avant-garde project.

With a total length of 1.9 km, four lanes – two in each direction – and two tram lines, the Basarab Flyover Bypass will relieve city centre congestion by directing the inbound traffic, from the north of the capital, off to the south, west and east, thus keeping it away from the centre of Bucharest. The Bypass has been designed to support 4,000 vehicles a day and is expected to be used by 32 million passengers a year. The main structure is the five span Basarab cable-stayed bridge. The span lengths are arranged as follows – 57 m + 75 m + 168 m + 36 m + 30 m. The first two spans serve as counterbalances for the stay cables on the 168 m main span and the remaining two spans are not cable-stayed.

COMPLEXITY

A number of factors serve to make this stay cable bridge a complex project:

- ▶ It has an irregular, somewhat unsymmetrical, plan shape, both longitudinally and transversely – with ramps that enter and exit the lintel.
- ▶ It is a large bridge with a main span of 168 m and a single tower which would be equivalent to a bridge with two towers and 340 m span.
- ▶ It is in a seismic zone.
- ▶ It has two types of load – road and track – as well as a covered station in the centre of the main span.
- ▶ Its main span crosses over railway lines near the North Train Station.

STAY CABLES

The Basarab Bridge is a steel stay cable bridge featuring the BBR HiAm CONA stay cable system with 30 front stays and 30 back stays.

The stays – with sizes from 31 to 109 strands – were executed with 15.7 mm galvanized, 1860 MPa GUTS waxed strands, individually sheathed with a HDPE coating – providing a triple corrosion protection system – and enclosed in a white UV-resistant HDPE stay pipe.

Due to the large variety of stay cable sizes, a wide range of elements in different sizes were necessary. For example:

- ▶ Anchor heads – 60 Uni Head anchorages and 60 Nut Head anchorages, 11 different sizes.
- ▶ HDPE stay pipe – a total length of 4,865 m distributed in HDPE pipes with seven different outside diameters.
- ▶ AV deck pipe – seven different models of anti-vandalism deck pipe for a total of 60 cables.
- ▶ AV pylon pipe – 60 different models of anti-vandalism pylon pipe.

“ A NUMBER OF FACTORS SERVE TO MAKE THIS STAY CABLE BRIDGE A COMPLEX PROJECT ”

ANCHOR HEADS

Work started with the installation of the anchor heads. The Uni Head anchorages were installed on the deck, while in the pylon we used 60 mm adjustable Nut Head anchorages, allowing 20 mm for stressing and 40 mm for unstressing.

The upper anchors transfer their load to the pylon under transverse post-tensioning – pairs of curved tendons embracing each anchor level. We used the BBR VT CONA CMI system for this post-tensioning element.

The next job, prior to stay cable installation, was the preparation of the strands. A 160 m table was set up at the back of the bridge for cutting the strands to the required dimensions and peeling the HDPE sheathing at both ends. Simultaneously, mirror-welding for the HDPE stay pipe assembly was being carried out. After lifting the HDPE stay pipe, the installation of the stay cable began.

INSTALLATION CHALLENGES

Installation was performed using the strand-by-strand method, whereby a strand pushing machine placed at the top of each pylon raises each strand from the deck, up towards the pylon. When the strands reached the correct position, they were individually stressed from the deck with a mono-strand jack using the BBR ISOSTRESS tensioning method.

For us, the critical issue was the installation program – we started the installation of the first strand on 29 September 2010 and we had to finish before Christmas. A total weight of 439 t of steel strand – comprising 2,392 strands of lengths between 42 m and 164 m – had to be installed and first stage stressed (6-10% GUTS) in less than three months!

One major challenge was the fact that the stay cables could not be assembled and stressed →



Technical insight:

HiAm CONA anchorage options and BBR ISOSTRESS

HIAM CONA ANCHORAGE OPTIONS

Usually, the end of the stay cable from which the tensioning is performed – the stressing end – is fitted with an adjustable Nut Head anchorage. The opposite end, or the dead end of the cable, is typically fitted with a Uni Head or BBR Pin Connector:

The ring nut of a Nut Head is screwed onto the anchor head, which transfers the cable loads by contact pressure onto the support structure, whereas the Uni Head option transfers the load directly to the support structure.

The HiAm CONA Nut Head comes with a typical adjustability of 0, 60 or 120 mm.

In addition to the standard anchorage configuration, a compact configuration is available for special applications – such as cable replacement – and has smaller openings in the bearing plate.

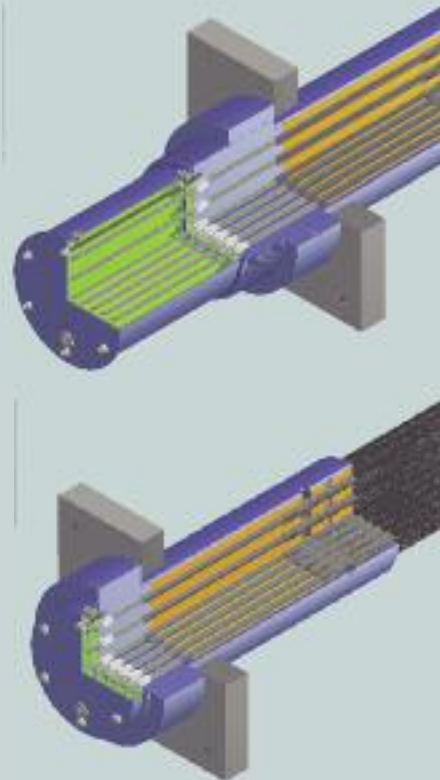

BBR ISOSTRESS

The installation of the HiAm CONA stay cable system is typically carried out on site using the strand-by-strand installation method.

After preparatory cable work – including installation of lower (deck) and upper (pylon) anchorage, strand pre-cutting and peeling and stay pipe assembly – is completed, the cable is lifted using two master strands to the anchorage locations. The two strands need to be cut to a longer length to account for the catenary effect. After stressing of the master strands, each individual pre-cut strand is pulled up through the stay pipe to the upper anchorage, before it is guided and fixed in the deck anchorage. Then, the strand is immediately tensioned with a mono-jack using the BBR ISOSTRESS method.

The BBR ISOSTRESS method requires two different stressing phases – stressing and adjustment. In the stressing phase, each single strand is tensioned to achieve a predetermined elongation which depends on the final load in the stay cable, deck and pylon stiffness, etc. The adjustment phase is carried out either with a mono- or multi-strand jack to ensure the correct final bridge deck geometry.

The BBR ISOSTRESS method ensures an equal stress distribution among the strands of an individual cable and complies fully with latest stay cable recommendations such as *fib* Bulletin 30 or PTI.

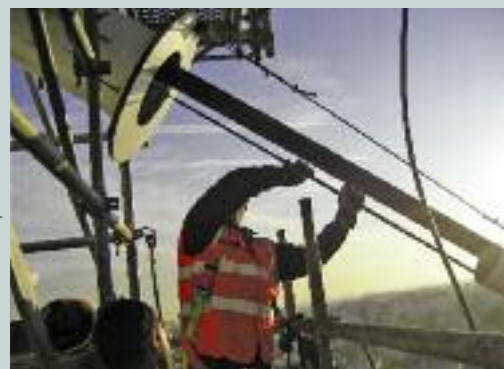

simultaneously, it had to be done individually. And there was one more problem – winter was fast approaching. With shorter working days because of diminishing daylight hours and temperatures below zero degrees, finishing the installation on time was a real challenge. In addition, 20% of the stay cables were placed over live railways – so their installation took more time because of the need for extreme precautions and safety measures in this area.

In spite of everything, we did it! On 16 December; just after the installation of the last strand, a heavy snowfall began – it seemed that the snow had waited for us to finish!

It was very important to finish on time because the tension in the strands achieved by first stage stressing allowed the deck slab

“ WHEN THE STRANDS REACHED THE CORRECT POSITION, THEY WERE INDIVIDUALLY STRESSED FROM THE DECK WITH A MONO-STRAND JACK USING THE BBR ISOSTRESS TENSIONING METHOD. ”

to be cast. Casting the deck took three months and when it was finished, the second stage stressing was performed – stressing from the pylon this time. A second adjustment in some stays was needed to complete the stressing work. The only remaining task was the closure of the stays and the injection of sockets and



protection caps. The injection work was carried out meticulously to ensure the steel elements were protected against corrosion. With this injection, and successful testing including a leak tightness test to the latest international standards on the BBR HiAm CONA system, we can reasonably assume a 100-year service life for the stay cables. The BBR VT CONA CMI post-tensioning system with multi-strand 1906 to 3106 anchors has been used in the construction of all the concrete viaducts that access the cable stay bridge. The connection between stages was achieved with single plane couplers. The length of the viaduct meant that a total quantity of 665 t of PT strand was installed.

FURTHER WORK

The main structure of Basarab Flyover Bypass was the cable-stayed bridge, but there was another task performed by BBR for this project.

At the end of the bypass, opposite the stay cable bridge, there is an arch bridge over the Dambovita River. We collaborated in its construction by assembling and stressing the hangers which provide a connection between the two arches and the deck. This





Basarab Flyover Bypass records

- ▶ The longest cable-stayed bridge in Romania (355 m)
- ▶ One of the widest cable-stayed bridges in Europe (43.3 m)
- ▶ The longest bypass in Bucharest (1.9 km)
- ▶ The largest intermodal point in Romania.

connection was performed by ten vertical hangers on each arch. The hangers were stressed by stressing the PT bars placed in the lower steel anchorages.

Yet another job realized by BBR on this project was the launching of a section of the steel bridge over railway tracks. The proximity of the structure to the railway network made it impossible for installation by crane, so launching techniques were necessary. This highly specialized heavy civil engineering work was the subject of an earlier article – see *CONNAECT 2011*.

The Basarab Viaduct is set to become Romania's benchmark for infrastructure construction, now that the benefits of innovative post-tensioning and cable-staying techniques, developed by the team at BBR PTE, have been fully explored and recognized during the evolution of this complex structure. ●

TEAM & TECHNOLOGY

OWNER City Hall of Bucharest, Romania
MAIN CONTRACTOR Basarab JV (FCC Construcción & Astaldi)
DESIGNERS Carlos Fernandez Casado S.L., Spain
 FHECOR, Spain
 C&T Engineering S.R.L., Italy
TECHNOLOGY BBR HiAm CONA stay
 BBR VT CONA CMI internal
BBR NETWORK MEMBER BBR PTE, S.L. (Romania)

PEDESTRIAN BRIDGE, BLACKBURN, SOUTH AFRICA

HIGHLIGHTING CAPABILITIES



The Blackburn Pedestrian Bridge – one of the longest cable-stayed pedestrian bridges on the continent – has recently been recognized with a prestigious **Fulton Award**. **Structural Systems Africa** provided specialist stay cable and post-tensioning services to the project which featured in the last edition of *CONNAECT*.

During the 2011 Fulton Awards, the Concrete Society of South Africa declared the Blackburn Pedestrian Bridge the overall Winner in the Civil Engineering category.

Among many aspects of this project, which features the BBR HiAm CONA Pin Connector; the judging panel were “impressed by the careful attention to design and detail, which was necessary due to

the uniquely shaped pylon.” They also commented that: “The towering pylon and fanning stays of the bridge highlight the capabilities of civil engineering and construction in South Africa.”

The judges praised not only the project itself, but also the way in which the professional team consulted and interacted with the community. ●



TEAM & TECHNOLOGY

OWNER South African National Highways Agency Limited (SANRAL)
MAIN CONTRACTOR JT Ross / Devru Construction JV
DESIGNER SSI Consulting Engineers
BBR TECHNOLOGY
 BBR HiAm CONA stay
 BBR Pin Connector
 BBR VT CONA CMI internal
BBR NETWORK MEMBER
 Structural Systems (Africa)



Untangling the traffic

OTOPENI BRIDGE, BUCHAREST, ROMANIA

The cable-stayed Otopeni Bridge over Bucharest's ring railway is – as well as being the second largest infrastructure project in the city after the Basarab Flyover Bypass – the third longest stay cable bridge in the country. Ana Contel, Romanian BBR Network Member, **BBR PTE**, describes the project.

Keeping road traffic moving on the DNI – a major national north-south route – as well as streamlining the junction area of the existing Otopeni Bypass has driven the need for improvements around the DNI and the Bucharest ring railway. To realize this, a multi-level intersection over the railway tracks and an overpass with four lanes was necessary. Until the construction of the new bridge, road traffic in this area ran to the right of the railway line, to a level crossing across the DNI, after which it continued on the left side



of the railway. The lanes connecting the DNI with the Bucharest ring road and the road to-and-from Otopeni, also met at this level crossing. The junction was completely outdated, given current traffic flows, and often caused road congestion – especially when the level crossing gates were closed.

The bypass over the railway lines has substantially improved the traffic flow in this intersection area, eliminating the queues and traffic jams at the junction.

The final solution for the design of the overpass was a cable-stayed bridge with a total length of 240 m and spans of 35 m + 85 m + 85 m + 35 m. The deck needed to be of a shallow depth because of the clearance required above the railway lines. To decrease the span length, a large pylon was sited in the centre of the bridge, breaking the central span into two sections. The design of



the pylon permits railway tracks to pass between its shafts. As the bridge is close to Bucharest's Henri Coanda Airport, the pylon height has been limited to 48 m to comply with aviation safety requirements.

Bucharest is in a highly seismic area, thus the main requisite was to minimize the mass of the structure. Accordingly, the pylon was designed with a hollow section of minimal thickness – apart from the area close to the foundations which has been designed as a full concrete section. Also, two steel cross beams between the pylons play an important role in the new structure's transversal seismic strength. Both the connection between the two sections of the pylon and the connection between the pylons and the cross beams, were executed with post-tensioned high tensile steel bars. The post-tensioning and injection of these bars was also carried out by BBR PTE. The deck and pylon are joined by 32 BBR HiAm CONA stay cables ranging in size between 20 and 34 strands and lengths from 32 to 95 m. This amounted to a total quantity of 72.5 t of steel strand for the stay cables, with a ultimate tensile strength of 1860 MPa and strand cross-section of 150 mm². The main operations – lifting of the HDPE stay pipe, threading and first stressing of the strands with the mono-strand jack – were carried out in only 20 working days! Total execution time, including the stressing with multi-strand jacks, the injection of the sockets and protection caps and the installation of the anti-vandalism pipes, was just two months – setting a new record. ●

TEAM & TECHNOLOGY

OWNER CNADNR SA-DRDP, Bucharest

MAIN CONTRACTOR

JV – FCC Construcción & Alpine Mayreder

DESIGNER FHECOR

TECHNOLOGY BBR HiAm CONA stay

BBR NETWORK MEMBER

BBR PTE, S.L. (Romania)

Sinking with success

2ND COENTUNNEL, AMSTERDAM, NETHERLANDS

The existing Coentunnel carries some 120,000 vehicles daily under the Noordzeekanaal, but it now forms a bottleneck on the A10 motorway, with long queues every day. A new immersed tube tunnel is under construction to improve traffic flows around Amsterdam. Ben Grundlehner of BBR Network Member **Spanstaal** explains the major role that BBR technology is playing in the creation of the 2nd Coentunnel. →



Rijkswaterstaat, the government body responsible for ensuring the smooth flow of traffic and water on national networks, awarded a €500 million 30-year design, build, finance and maintain (DBFM) contract – which includes construction of the second Coentunnel – to the Coentunnel Company.

The new structure was to be constructed with immersed tube tunnel elements – built in the existing dry dock at Barendrecht and transported to the tunnel site where they would be submerged. Four elements were required – each over 178 m long and consisting of seven sections,

each of the latter were around 25.5 m long, almost 30 m wide and more than eight meters high. Construction of one section took about a month – the four elements only just fitted in the dry dock, so

good workspace and materials planning was vital. During transportation and immersion, large forces arise on tunnel elements – and this is critical at section joints. So, it is now common practice to construct post-tensioned tunnel sections.

Although at first PT tendons only performed a temporary function – during transportation and immersion – since the mid-1980s, they have been used to give more permanent strength to tunnels. In the early days, the tendon ducts were not injected with grout and it was possible to remove the tendons after immersion – the thinking was that they could be used again for future tunnel construction activities. The modern view of tunnel design is that post-tensioning plays an enduring role, whereby ducts must be grouted to achieve a bond between the PT steel and the encased concrete and thus creating greater strength from their synergy. Also, grout supplies the protection needed against corrosion. This working method presented two challenges:

- ▶ To conquer the friction between the bottom of the tunnel and the dry dock (working) floor; grouting operations would mainly be carried out after the dry dock had been flooded.
- ▶ To avoid the unverifiable forces after immersion, often the grouted cables would be severed at joints between two adjacent segments, so that a tunnel element could settle down onto the subsoil.



Tunnel construction in the Netherlands

Its position – on the North Sea and at the delta of the Rhine and Maas rivers – means that water has always been an important consideration in creating infrastructure in the Netherlands. Tunnels play a vital role in providing river crossings, where sometimes ocean-going vessels or occasionally inland ships in rivers and canals influence the way these are delivered. This is why most tunnels in the Netherlands are built using ‘immersed tube’ tunnel methodology. The first river-crossing with a rectangular concrete cross-section to be built using the immersed tube method was the Maas Tunnel in Rotterdam which opened in 1942. Since then, dozens of road, railway, metro and also pipeline tunnels have been constructed here using this method. Our experience has also been exported to other countries – including the UK, Germany, Denmark and Korea.

Typically, tunnel elements are constructed in temporary locations – rather than on the alignment of the finished tunnel. They are built in a dry-dock and floated out to their final positions on the river crossing. Here, they can be sunk to the right depth and place in a very short time, thus presenting only minor disruption to shipping.

During the last 50 years, technology has changed dramatically – making it possible to prefabricate and transport longer-and-longer elements. For example, the first Coentunnel – built in 1961 – had six 90 m long immersed units. Now, almost five decades later, the second Coentunnel is being constructed with four 178 m long immersed units.

Many dozens of tunnels have been constructed in the Netherlands, the majority of these were built using immersed tunnel sections which were post-tensioned for transportation. Most of the associated post-tensioning works were carried out by Spanstaal – using diverse and flexible BBR technology.

PT TACTICS

The selection of the Barendrecht dry dock – necessitating transportation by sea – combined with the choice of four 178 m long tunnel elements meant that large post-tensioning forces had to be delivered. We used 1906 BBR CONA tendons – and installed 38 tendons for the two outermost elements and 44 for the two innermost elements. Each tendon consisted of 19 15.7 mm diameter strands of 1860 MPa steel quality and strand cross-section of 150 mm². This delivered a post-tensioning force per element of 161,000 kN and 187,000 kN respectively – roughly equally divided over the roof and bottom of the segments. The tunnel elements were fabricated in two production streams of two elements each. Before casting of the bottom and roof sections, 100/106 mm diameter ducts were placed and, at the same time, anchor plates for the post-tensioning tendons were installed. So-called ‘de-bonding tubes’ were placed at section joints. These measures ensured that prestressing forces could be introduced smoothly into the concrete.

After finishing the tunnel elements, the PT tendons were placed, using the strand-by-strand installation method and with the help of a pushing machine. Then the cables were stressed until they reached the required force. Normally, prestressed tendons would immediately be injected with grout now, to give them corrosion protection – however, in this case, it was not possible. Pressure created during prestressing causes shortening of the concrete. This shortening would have been prevented between the tunnel bottom and the dry dock floor. If the duct had been grouted in this position, then the prestress forces in the joint would have been reduced. This was resolved by grouting the ducts – from a pontoon – when the tunnel elements were partially floating in the flooded dry dock.

TRANSPORTING ELEMENTS

After producing the four tunnel elements, preparations were made to transport them from the production site in Barendrecht to the building site in Amsterdam. First of all, the four elements were provided with temporary watertight bulkheads at both ends, allowing them to float during transportation. To facilitate this, each element was longitudinally prestressed to ensure that, during its three day voyage, the construction



remained watertight – even when exposed to waves in the sea. The route was across the River Maas from Barendrecht, to Hoek van Holland and further across the North Sea to the locks of IJmuiden and finally, across the Noordzeekanaal to Coenhaven in Amsterdam – a total distance of 160 km.

SEQUENCE OF EVENTS

At the end of January 2011, the dry dock was ready for flooding and then several tasks were executed, including the grouting of ducts. In March, the four tunnel elements were individually transported to Amsterdam. In April, the first element was submerged – the last element was sunk at the end of May. Consequently, the post-tensioning tendons at the section joints were severed. Thus, the

prestressing had completed its work for the transportation and immersion phases and now continues to contribute to the strength and stiffness of each section. It is expected that the second Coentunnel – together with the new Westrandweg – will be opened to traffic in 2012 and together they will provide better traffic circulation and access for vehicles in-and-around Amsterdam. ●

TEAM & TECHNOLOGY

OWNER Rijkswaterstaat

MAIN CONTRACTOR Coentunnel Company

SUBCONTRACTOR & DESIGNER
Coentunnel Construction

TECHNOLOGY BBR CONA internal

BBR NETWORK MEMBER
Spanstaal B.V. (Netherlands)

“ ...THE PRESTRESSING HAD COMPLETED ITS WORK FOR THE TRANSPORTATION AND IMMERSION PHASES AND NOW CONTINUES TO CONTRIBUTE TO THE STRENGTH AND STIFFNESS OF EACH SECTION. ”





SUNGAI SIOL BRIDGE, MATANG, SARAWAK, MALAYSIA

TIMELY TESTING SOLUTION

When problems arose with pile testing on the three span Siol River Bridge in Sarawak, Tie King Bang of **BBR Construction Systems Malaysia**, reports that they were asked to take over piling operations and provided innovations which rescued the situation. He describes how a successful and economic method for large diameter pile testing can be provided by applying post-tensioning to vertical reaction piles with a horizontal steel beam.

Each bridge pier is supported by three 1,200 mm diameter bored piles and two 750 mm diameter raked bored piles. Ground conditions meant that it was not practical – and costly – to carry out a maintained load test using concrete blocks for kentledge. The initial pile test – using the biaxial load method, with an embedded hydraulic jack – had been unsuccessful.



The test load of the pile was 1800 t – twice the working load. A new pile was installed to act as an anchor pile and replace the failed one which was at the edge – the center pile was selected for the next test.

Anchored nearer to the test pile, the new pile would experience higher pulling forces due to the smaller lever arm. Consideration of the forces for both anchor piles was reflected in our geotechnical design. Strands were embedded in the anchor pile during the bored pile construction. A steel plate girder was placed over the anchor piles and post-tensioned to them. Load was applied to the test pile by jacking the top of the test pile to the soffit of the plate girder:

The anchor piles were subjected to high pull-out forces during testing – and had been anchored more deeply than the test pile for this reason. Additional main reinforcement to the bored pile was required at the rock socket region to control tensile stresses and minimize structural cracking during testing. Each anchor tendon was preloaded to

40% UTS before commencing the load test to reduce the elongation of strands during testing which, if excessive, would have lifted up the test beam.

Each anchor pile consisted of four BBR CONA 1906 tendons, with their dead end anchorages inside the rock socket region. The strands near the top of the pile were debonded by installing the PE sheath to a depth of 25 m.

Two hydraulic jacks, with a 2,000 t combined capacity, were used to jack against the test pile and plate girder: At each load increment/decrement, the deflections were monitored over three load cycles.

The installation of the long, heavy tendons into the anchor pile was a challenge. They were tied to the reinforcement cage of the bored pile and the dead ends were staggered to avoid congestion and ease concreting. The entire assembly was lifted and lowered carefully into the bored hole.

The project team wanted a strong plate girder which could be assembled in easily transportable modules. We achieved this by dividing the girder into two separate steel box girders – each 1,000 mm wide, 1,600 mm high and weighing 20 t. They were laced together at the top and bottom of the plate girders using channels to ensure they behaved monolithically under loading. ●

TEAM & TECHNOLOGY

OWNER Public Works Department, Sarawak

MAIN CONTRACTOR Zecon Berhad

TESTING DESIGNER/CONTRACTOR BBR Construction Systems (M) Sdn Bhd

BBR TECHNOLOGY BBR CONA internal

BBR NETWORK MEMBER

BBR Construction Systems (M) Sdn Bhd (Malaysia)

RIVER DANUBE BRIDGE, VIDIN – CALAFAT, BUGARIA & ROMANIA

VESSEL IMPACT PROTECTION

The new major road and rail bridge being built across the River Danube in eastern Europe will boost traffic links between Bulgaria and Romania. Crossing this navigable waterway, however, means that vessel impact protection is needed for the bridge piers, Enrique Arana from **BBR PTE** describes the scheme and their work.

The new crossing which includes a main bridge with three 180 m long extradosed spans, is on transport corridor IV of the Trans-Europe Network and links Germany to Turkey through Romania, Bulgaria and Greece.

The new river crossing connects the towns of Vidin, in Bulgaria and Calafat, in Romania. At this point, there is an island in the River Danube which makes a convenient stop-over for the bridge and enables it to be divided into three main sections.

First, there is a low-level rail approach viaduct with 40 m long spans on the Bulgarian river bank, next comes a 612 m long viaduct over the non-navigable channel that has eight spans, of which all but one are 80 m long and finally a single-cell box girder bridge over the main navigation channel. This main bridge has five spans – three spans of 180 m, one of 124 m and another of 115 m. The 400 m long low-level viaduct serves to align the road and rail lines correctly as they approach the main crossing.

To protect the bridge piers from vessel impact, 152 precast prestressed concrete units are being installed. On the bridge section over the navigable waterway, each of the four pile caps – on which the bridge piers will be formed – will be protected by 38 units. Seven different types of unit are being cast in the onsite casting yard. The 'heavy' ones weigh 120 t



and the 'lighter' ones are 70 t each. In the yard, two structures have been designed for vertical storage of the units (which is the correct position for installation) and these stand close to the jetty crane for ease of loading onto the mobile pontoon. To allow this storage, they are turned hydraulically from horizontal to vertical. When both units have been loaded onto the special structures welded over the pontoon, the pontoon travels a distance of more than two kilometers to the pile cap – a journey of

around 45 minutes. On arrival, the pontoon is positioned and secured to the pile cap structure.

A purpose-designed steel structure then lifts and positions the units correctly on the pile cap. Three 250 bar 85 t heavy lifting jacks at the top of the structure carry out the lifting, turning and positioning maneuvers.

Joints between the pile cap and the vessel impact protection require filling with mortar and we are carrying out a two phase grouting process. When the prestressing of

the units has been completed, the structure moves to the next pier cap – by which time the next units will be ready. ●

TEAM & TECHNOLOGY

OWNER Republic of Bulgaria: MT-PIMU

MAIN CONTRACTOR FCC Construcción S.A. Klon Bulgaria

DESIGNER Carlos Fernandez Casado S.L.

TECHNOLOGY Heavy lifting

BBR NETWORK MEMBER

BBR PTE, S.L. (Romania)



WELLINGTON DAM, COLLIE, WESTERN AUSTRALIA

Australian BBR Network Member **Structural Systems** is continuing its recent run on high capacity ground anchoring projects with the remedial works to Wellington Dam in the south west of Western Australia. The existing concrete gravity structure has been strengthened with the addition of ground anchors, using BBR VT CONA CMG technology with anchors of up to 91 strands – equaling the current world record capacity. Mark Seisun, Project Manager, takes up the story which was first reported in *CONNAECT 2011*.

Wellington Dam is owned by the Water Corporation of Western Australia and was constructed on the Collie River in 1931 as a mass concrete gravity structure. Originally 19 m high and 232 m wide, the dam wall was raised one meter in 1944 and an additional 15 m in 1960, to give the dam its present 34 m height, with a total wall length of 366 m. The dam has a capacity of 186 million kilolitres when full and provides irrigation waters for the region's farming community. As part of the Water Corporation's state-wide dams safety and maintenance program,

important works were required to bring Wellington Dam into line with current engineering standards. In response, a process of identifying, analyzing, evaluating and culling of various options was undertaken to either strengthen, replace or lower the dam. The final design incorporated 43 permanent ground anchors to strengthen the existing concrete gravity structure, as well as an access bridge for both the construction and future servicing of the anchors. The Wellington Dam Alliance was formed between Leighton Contractors, Structural



Systems, Entura (dam design consultants) and AECOM (bridge design consultants) in partnership with the Water Corporation. The Alliance designed the access bridge incorporating a deck that would 'wash away' during a peak flood event to ensure the dam's safety.

The design of the bridge is unique in several ways. The bridge piers serve the dual purpose of supporting the bridge deck as well as housing and protecting the anchor heads. To ensure retention of the bridge deck's 'wash away' capability during extreme flood events, Teflon bearings and an adjustable HDPE guide system were developed.

ACCESS CHALLENGE

The significant challenge of the bridge construction work was gaining safe access to the dam's spillway and, for this, extensive temporary works were commissioned. These works included a low-level platform which served to provide access to the bridge piers during construction, as well as providing a rail for task-specific construction trolleys to run on. A series of trolleys were developed which ran on the access platform rail and a second rail fixed to the spillway crest. The trolleys were fitted with overhead monorail hoists to complete the tasks of initially constructing the access platform as they advanced, wire sawing and concrete removal for the bridge pier notch, drilling and installation of starter bars to the notch, plus the reinforcement, formwork and concrete placement for the bridge piers. The pier construction work was assisted with lifting capacity for formwork,

Leaders in ultra-high capacity anchors

reinforcement and concrete by 50 t crawler cranes that were installing the precast concrete bridge decks close behind the advancing pier construction. Two construction teams advanced from either side of the dam, constructing the bridge to meet at the spillway's midpoint. A specialist drilling contractor was engaged on the project to drill the 355 mm diameter holes with a purpose-built drill rig utilizing a down-the-hole hammer:

Our team was focused on the fabrication, installation, grouting and stressing of the 43 permanent ground anchors. The anchors were the same design as we used on our recently completed dam projects at Catagunya and Tinaroo and incorporated BBRVT CONA CMG technology for vertical

anchor sizes of 31, 42, 55, 65 and 91 x 15.7 mm (279 kN MBL) strands. The 91 strand anchors equal our previous world record capacity anchors installed at Catagunya in 2010 with an MBL of 25,389 kN. The anchors are monitorable and restressable with a design life of 100+ years. Anchor lengths varied from 64.2 m maximum to 18.4 m minimum.

PIVOTAL ANCHOR TECHNOLOGY

The availability of the high capacity CONA CMG 9106 anchor technology was pivotal to the design's viability. The final design required two 9106 anchors per 50 ft wide concrete monolith across the spillway. As the bridge piers double as anchor housings, the number and location of piers was determined

Facts & figures

- ▶ Permanent anchors = 31-91 x 15.7 mm diameter strands
- ▶ Vertical anchors = 18 or 64 m long each
- ▶ Bond length = 12 m each
- ▶ Drill hole size = 355 mm diameter
- ▶ Minimum breaking load = 25,389 kN
- ▶ Test force = 19,042 kN (75% MBL)
- ▶ Lock off load = 18,280 kN (72% MBL)
- ▶ Design working load = 16,503 kN (65% MBL)
- ▶ Strand tonnage = 230 t
- ▶ Class G Oilwell Cement & GP cement = 221 t

by the anchoring requirements. A reduced anchor capacity would have required increased anchor numbers and subsequently increased the number of bridge piers from 30 to 45 – significantly impacting on spillway discharge characteristics and ultimately the solution's viability. The anchoring works commenced in November 2010 and were completed in June 2011 – two months ahead of program. The on site anchor fabrication facility used purpose-built equipment to grease and sheath with HDPE each individual strand's free length with the bare bond lengths (up to 12 m) being steam cleaned to maximize bonding to the grout. The individual strands were assembled into the completed anchor using a series of spacers and strapping to the bond zone to form an hourglass effect, maximizing the load transfer into the surrounding rock, via the high strength grout.



The completed anchor was transported on public roads to the dam wall on a series of up to 30 purpose-built trolleys, negotiating some difficult bends and steep declines along the way. Anchor installation was completed in two stages. First the 280 mm diameter HDPE outer sheath was installed. This consists of an HDPE →





corrugated sheath over the bond length with 7.5 m lengths of HDPE smooth sheathing fusion-welded on site to form the free length sheath. As this sheathing is the primary form of corrosion protection for the anchor, its integrity is critical and it is pressure tested with water to detect and allow the repair of any leaks that may be observed.

Installation of the anchor into the installed sheath was achieved with a custom frame and a 17 t braking winch to control the rate of descent. The anchors were suspended in the hole during the grouting process which uses Class G Oilwell cement to the bond length and GP cement to the free length.

TAILOR-MADE STRESSING JACK

Following 28 days minimum grout curing time, the anchors were stressed using a purpose-built 2,200 t capacity hydraulic jack. Typically each 9106 anchor was proof loaded to 75% MBL (19,042 kN) and locked off at 72% MBL (18,280 kN). With the recent development of the low-friction strand entry transitions to the BBR VT CONA CMG anchor heads, excellent results have been achieved during stressing. No strand or wire failures have occurred within the three projects (168 anchors) where we have used this technology to deliver the world's highest capacity permanent ground anchors.

The overall success of the project is reflected in the numerous engineering and safety awards for which the project has been nominated. Meanwhile, the successful completion of the anchoring works further advances Structural Systems' position as world leaders in the development and execution of ultra-high capacity permanent ground anchors. ●

TEAM & TECHNOLOGY

OWNER

Water Corporation of Western Australia

MAIN CONTRACTOR

Wellington Dam Alliance (WDA) comprising Leighton Contractors, Structural Systems, Entura and AECOM in partnership with the Water Corporation

TECHNOLOGY BBR VT CONA CMG ground

BBR NETWORK MEMBER

Structural Systems Limited (Australia)

REINFORCED SOIL STRUCTURES, POLAND



ONE GIANT LEAP

The much anticipated completion of their first soil-reinforced construction project was the final step in implementing this technology and a challenge for engineers, reports BBR Polska engineer Marcin Harhala who has had much experience of deploying this technology.

Our first project using panel wall technology was built near Warsaw – in Nowy Dwor Mazowiecki. The viaduct on which the reinforced fill technology was applied forms part of a scheme to upgrade the E-65 Warsaw to Gdynia railway line. The total surface area of 2,255 m² consisted of four retaining walls – of varying heights – backing onto two embankments. In one embankment, there was a culvert for pedestrians – its location made this one of the most challenging parts of the construction project.

We participated in a four week design period, aimed at optimizing materials and methodology. Retaining walls were designed as reinforced fill construction with intractable reinforcement, using a IBDiM-compliant panel wall system consisting of elevated panels and steel zinc-coated wire mesh forming the soil reinforcement, with backfill placed in successive layers.



The project involved the installation of 606 prefabricated panel units, of which 294 were designed as atypical elements to reflect the slope of the road. The basic 1,829 mm x 2,440 mm x 140 mm panel walls were all produced to concrete bridges class C30/37 standards, thus meeting additional requirements regarding absorbability and frost-resistance. We also used around 50 t of steel mesh on the project. By choosing this type of prefabricated panel wall, we were able to construct two retaining walls with a total area of 788 m² in just four weeks, as well as placing some 4,530 m³ of backfill and compaction. The city centre location required well thought out logistics and organization for handling materials, as storage on site was practically impossible. The knowledge and experience gained from this first implementation will allow us to optimize the design and improve the detailing and assembly on site. We now look forward to securing still more demanding projects and deploying further new technological developments. ●

TEAM & TECHNOLOGY

OWNER PKP-PLK (Polskie Koleje Państwowe – Polskie Linie Kolejowe)

MAIN CONTRACTOR Intercor Sp. z o.o.

TECHNOLOGY Panel wall

BBR NETWORK MEMBER
BBR Polska Sp. z o.o. (Poland)



CHEMICAL INDUSTRY GETS A LIFT

PRILL TOWER, MORANBAH, QUEENSLAND, AUSTRALIA

In Central Queensland, Australia, BBR Network Member **Structural Systems** was recently engaged to provide heavy lifting services utilizing BBR VT CONA CMI technology for the erection of a Prilling Skirt in the construction of a new Ammonium Nitrate plant.

During manufacture of Ammonium Nitrate – required for explosives in Australia’s mining industry – the liquid Ammonium Nitrate needs to be prilled. This process, which involves the chemical being sprayed and cooled to form solid beads, is performed within a Prill Skirt. The Prill Skirt for the new plant is approximately 11 m by 6 m in plan and is 49.5 m tall. It is designed as a relatively lightweight stainless steel construction to be hung from the Prill Tower structure.

After the tower’s structural frame had been completed and the lifting equipment installed, the Prill Skirt modules were fed in at ground level. The most critical aspect was the necessity for the project team to be working on the suspended load – performing specialized stainless steel welding procedures – without compromising safety. Our heavy lift system gave the project team the required confidence in safety over-and-above any alternative lifting system available.

“

... THIS WAS A VERY COMPLEX AND CRITICAL PART OF OUR PROJECT. IT WAS ESSENTIAL THAT THE ERECTION OF THE SKIRT WAS COMPLETED WITHOUT DELAYS, WITH NO SAFETY CONCERNS AND THAT THE 160 T OF SUSPENDED MATERIAL WAS FULLY CONTROLLED AT ALL TIMES WITH A LARGE SAFETY FACTOR ALLOWED FOR ON ALL THE LIFTING AND LOWERING PROCEDURES. ... IT HAS BEEN A VERY SUCCESSFUL OPERATION FOR THE PROJECT ... ”

**JOHN ROBERTS,
SUPERINTENDANT,
ALLIANCE JOINT VENTURE**

The complete skirt weighed approximately 150 t and we utilized four purpose-built heavy lift hydraulic jacks for the operation. A set of laser distance measurers were used to monitor the Prill Skirt’s height and level during lifting. A typical 5.5 m high lift took less than four hours to complete. The lifting tendons consisted of 15.2 mm (260 kN MBL) strand and utilized 706 BBR CONA VT CMI anchor heads with wedge retaining plates for connection to the load via a custom-built clevis and pin arrangement. One of our challenges was dealing with the large load variations due to the staged lifting process. With the initial lift being less than 10 t, only two strands were engaged upon lift commencement, thus ensuring adequate strand loads to provide the necessary wedge draw-in and seating pressure. As the weight of the lift increased, through the staged addition of modules, additional strands were engaged in the lifting tendons. The complex lifting and Prill Skirt assembly process was completed over a period of approximately four months and deemed a highly successful operation. ●

TEAM & TECHNOLOGY

OWNER Dyno Nobel Asia Pacific

MAIN CONTRACTOR Alliance Joint Venture between United Group Ltd, Bilfinger Berger Services and BGC Contracting, Australia

TECHNOLOGY BBR VT CONA CMI internal Heavy lifting

BBR NETWORK MEMBER
Structural Systems Limited (Australia)



AL-WEHDAH DAM, IRBID, JORDAN

Strength against forces

BBR Network Member, **Marwan Alkurdi & Partners** has been working on a technically demanding construction project for the new Al-Wehdah Dam. The site is in the northern part of the Hashemite Kingdom of Jordan on the Yarmouk River which forms the border between Jordan and Syria in this location.

The Al-Wehdah Dam is a roller-compacted concrete (RCC) dam, designed for construction in two stages. The first stage takes it to 70 m high to a crest elevation of 116 m, and the second stage involves raising it by 30 m to a crest elevation of approximately 146 m.

The owner required that provisions should be included to permit the raising of the dam at a later stage. The dam was constructed using grout-enriched RCC (GERCC) facing on both the upstream and downstream surfaces. A grout curtain cut-off was constructed at the upstream foot of the dam and the abutments were extended to a depth sufficient to accommodate second stage construction. The multi-stage intake structure consisting of a



tower with three intakes at heights of 70 m, 80 m and 90 m – along with two concrete-encased 3 m diameter steel conduits and a discharge structure – was constructed in the left abutment.

Our scope, as nominated subcontractor, consisted of the construction of all the CVC



(Conventional Vibrated Concrete), in addition to all necessary upstream and downstream facing formwork using climbing formwork at the upstream face and stepped formwork at the downstream face and for gallery construction.

The very tight schedule for construction demanded the use of special climbing formwork and scaffolding – plus a 24-hour working cycle, as the RCC work was carried out in a continuous 24-hour operation. In just 72 hours, we had completed the formwork for the grouting gallery – approximately 1,170 liner meters of three meter high galleries of widths varying from 1.5 m to 2.4 m. The PT bar technology helped us gain time and enough strength to deal with the great forces induced by the RCC placement and the working equipment.

TEAM & TECHNOLOGY

OWNER The Ministry of Water and Irrigation, Jordan Valley Authority

MAIN CONTRACTOR Ozaltin Construction Trade & Industry Co.

DESIGNER Montgomery Watson Harza (MWH)

CONCRETEWORKS Marwan Alkurdi & Partners Co. Ltd. (Nominated Subcontractor)

TECHNOLOGY PT bar; climbing formwork

BBR NETWORK MEMBER Marwan Alkurdi & Partners Co. Ltd (Jordan)

TRIATHLON VIP ZONE, LONDON, UK

First for temporary PT structure

UK-based BBR Network Member, **Structural Systems** has been busy assisting with preparations for the 2011 Hyde Park's Dextro Energy Triathlon ITU World Championship by constructing a temporary structure which forms the Tata Steel VIP zone.

The pavilion is constructed from 'post-tensioned steel technology' which is an innovative solution and believed to be the first of its kind to be applied to such a temporary structure in the UK.

Structural Systems has been working in collaboration with S2 – an Australian company which specializes in the design and construction of large span steel solutions. The structure comprises a post-tensioned structural steelwork hollow section latticed arch that is pinned at each corner.



TEAM & TECHNOLOGY

OWNER TATA Steel

MAIN CONTRACTOR TATA Steel

DESIGNER S-Squared Corporation Pty Ltd

BBR NETWORK MEMBER Structural Systems (UK) Ltd

The Christchurch earthquakes

– the BBR Network's response

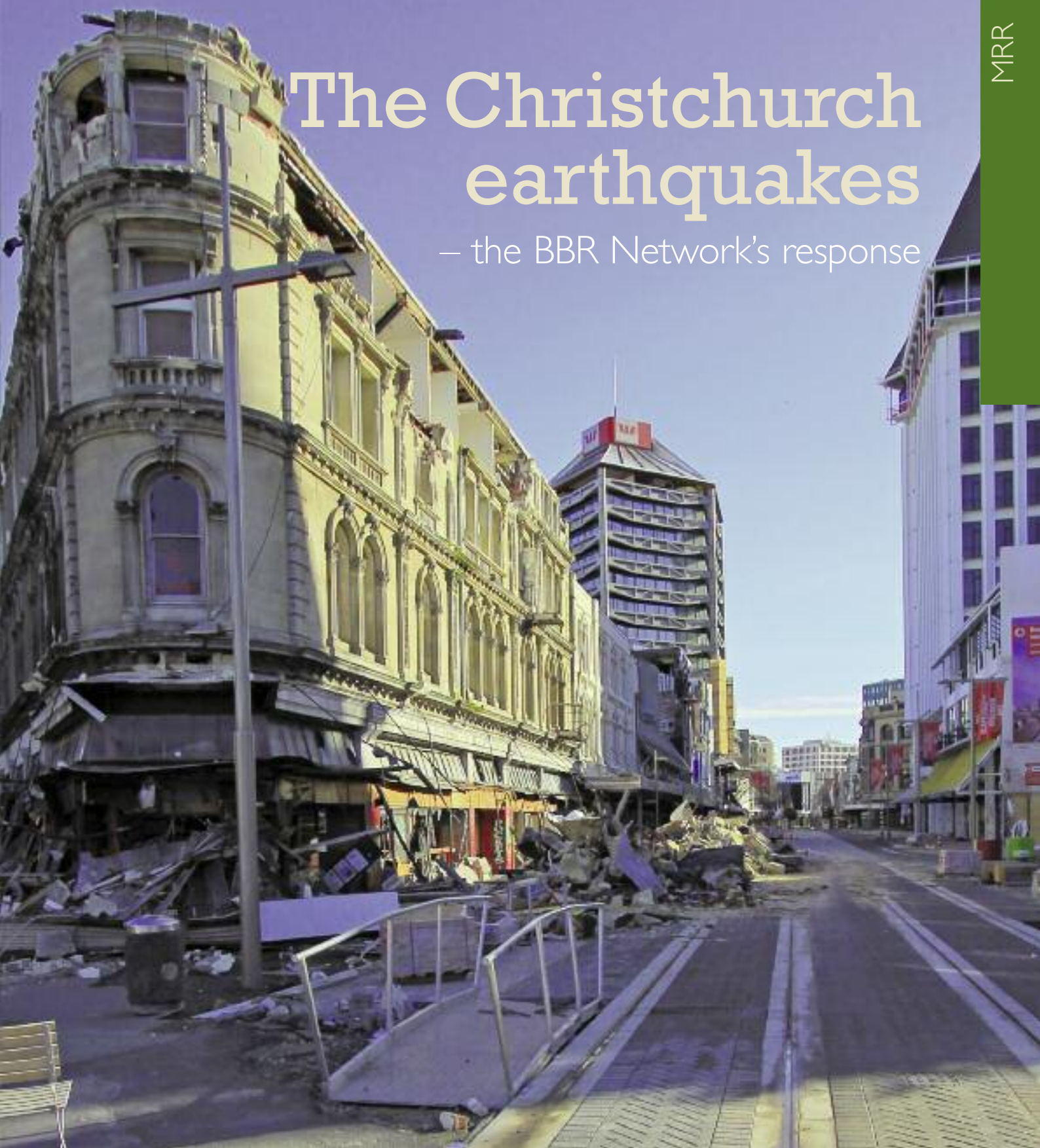

The earthquakes that struck New Zealand's 'Garden City' in 2010 and 2011 have left many of its buildings in ruins and others in urgent need of repair. The BBR Network is proud to be helping the city get back on its feet – and curious to see

how projects on which it has worked in the past have fared through the earthquakes and the 8,000+ after-shocks that have followed. **BBR Contech's** Southern Regional Manager, Peter Higgins, reports on the work associated with the response and reconstruction. →



Most of the damage in Canterbury was caused by three massive quakes – the first on 4 September 2010 (7.1 magnitude on the Richter Scale), the second on 22 February 2011 (6.3) and the third on 13 June 2011 (6.3). These – plus further earthquakes in December 2011 and the thousands of aftershocks – wreaked havoc on the region, with many buildings damaged in the first earthquake being utterly destroyed in later ones. The very high ground accelerations, liquefaction and occurrence of successive earthquake events are unprecedented internationally and buildings have been subjected to some extreme loading.



“BASED ON THE SUPERIOR PERFORMANCE OF POST-TENSIONED SLABS, THERE IS A HIGH LEVEL OF INTEREST IN USING POST-TENSIONED SLABS-ON-GROUND FOR NEW BUILDINGS AND TO REPLACE DAMAGED FLOORS”



Of those which have survived, a significant percentage need repair and restoration. BBR Contech has been kept busy as a result, working on more than 50 projects in the Christchurch Central Business District (CBD) and beyond. The work has predominantly focused on commercial and industrial structures, as well as infrastructure and a wide range of specialist activities have been necessary.

POST-TENSIONING PERFORMANCE

Over the past 10 years, BBR Contech has delivered over 30 post-tensioned slab-on-ground projects in Christchurch, ranging in size from 1,500 to 32,000 m². These buildings are in various locations throughout the earthquake-affected region and have performed to a very high level. With relatively high compression forces integral to the design and a minimum of joints, post-tensioned slabs have the ability to resist high loadings and to bridge over areas of local weakness. The performance of these slabs has not disappointed in Christchurch, with virtually no damage reported. Many warehouses and storage facilities suffered from collapsed racking, plus damage to other building elements. However, the post-tensioned floors remained intact and provided a solid foundation to effect a rapid clean-up – and were ready for service again once racking and stock was replaced. The slabs have resisted high ground accelerations and the self-restoring characteristics of the post-tensioning have enabled the floors to mitigate the effects of the ground motions and weak subgrades. Other buildings, with conventionally reinforced floor slabs, have suffered significant damage and the floors are likely to require replacement. There is also

On the record: with Professor Stefano Pampanin



Professor Stefano Pampanin is Associate Professor of Structural Engineering at Canterbury University, Christchurch. He was invited to become a member of the Expert Panel of New Zealand's Department of Building and Housing, reporting to and advising the Royal Commission of Inquiry (RCI) into the earthquakes

which, in October 2011, released its preliminary observations. Among other things, the report recommends consideration of new construction technologies.

For the international construction engineering community, the Christchurch earthquakes delivered no major surprises. There were buildings designed according to older design standards and technology here – as indeed all around the world – that have been well-known for their inherently higher seismic vulnerability. Perhaps the biggest shock was the severity of the 22 February 2011 'aftershock' – although of smaller magnitude than the main event on 4 September 2010, it was shallower and the level of shaking was almost twice what a newly designed building is currently required to withstand. Without the outstanding legacy of Earthquake Engineering techniques here in New Zealand, we could have been counting casualties in thousands, rather than hundreds.

There is now a strong need to communicate what we have learnt and what the latest technology can offer. Forward-looking dialogues have been opened with the people and work is underway with government departments to ensure that new construction meets higher seismic standards. The insurance industry is already playing its critical part in this process by requiring proof that a building to be insured incorporates latest damage-resistant technology. The bottom

line is that, in today's society and in spite of the severity of the earthquake, we cannot afford to have so many buildings damaged beyond reparability – aside from safety or social considerations, downtime costs are higher than they were even just a couple of decades ago.

Progress has now delivered better building technology, offering a cost-effective approach. The PRESSS system, consisting of post-tensioned rocking/dissipating precast concrete connections, and its very recent evolution and extension to the timber construction industry, or Pres-Lam system, developed by our team at the University of Canterbury, promote damage-resistant construction capable of sustaining severe earthquake shaking with a minor level of damage and business interruption. At present, there are almost 10 PRESSS (concrete) and Pres-Lam (timber) buildings either underway or completed in New Zealand – and many feasibility studies and preliminary designs under consideration. The development and introduction of the Pres-Lam system as a viable alternative solution for multi-storey timber buildings, has sparked some healthy activity within the construction market, previously dominated by just two materials or 'industry champions' – steel and concrete. With a new and very serious contender entering the arena, much innovation is underway to demonstrate that they can all offer the same level of safety at a competitive cost.

The reconstruction of Christchurch is an overwhelming challenge – one single industry alone cannot possibly deliver it and this is fostering greater collaboration between industries. It's often said that you can emerge stronger and better from a crisis and that's hopefully going to be true here too – this is our great opportunity to make something absolutely brilliant, after such a catastrophic event, and contribute to the creation of a safer and more beautiful place to live. My congratulations to BBR Contech for being one of the few leading organizations which has truly understood the value of investing time and resources in research and development of new technologies both for the design of new buildings and for the retrofitting of existing structures. They are well-aligned to benefit from their early experience of using new technologies and materials and I look forward to our continued working relationship, as we explore yet further new damage-resistant design techniques.



Post-tensioned warehouse floors remained intact, providing a solid base for the clean-up of collapsed racking, and businesses were quickly able to resume trading.



substantial damage to saw cuts and movement joints, as a result of lateral displacements and pounding. Based on the superior performance of post-

ensioned slabs, there is a high level of interest in using post-tensioned slabs-on-ground for new buildings and to replace damaged floors. A cost premium sometimes

exists for smaller floor areas, but the value added by the prospect of minimal business interruption is now very much in the mind of building owners and tenants. →

DAMAGE RESISTANT DESIGN TECHNIQUES

In addition to slabs-on-ground, there is also growing interest in using post-tensioned technology in damage resistant design techniques for multi-storey buildings. Precast Seismic Structural Systems (PRESSSS) technology developed in the United States (see *CONNAECT 2008*, page 74) has been utilized on concrete buildings and now the new Pres-Lam system – which uses post-tensioned timber frames – has been

developed in New Zealand. Several buildings have already been constructed and further projects are underway. BBR Contech has provided post-tensioning for three of these schemes and is associated with ongoing research and development. The considerations and consequences of many months of downtime, loss of occupancy and sometimes irreparable level of damage is now receiving much greater attention from building owners – not just in Christchurch – but all over New Zealand.

REMEDIAL WORKS

BBR Contech's remedial works in the past 12 months have covered a wide range of structures, from historic buildings to modern towers, shopping malls, hospitals and bridges.

Pres-Lam resists the shakes

Instead of concrete, Pres-Lam incorporates laminated veneer lumber (LVL) and delivers a similar result to PRESSSS by enabling the building to rock back-and-forth during an earthquake, then return to an upright position without significant structural damage.

Pres-Lam offers a number of benefits in comparison with concrete and steel construction:

- ▶ LVL is made from a renewable resource – New Zealand radiata pine.
- ▶ Significantly lighter than concrete – large components can be prefabricated then transported, also requires smaller on-site equipment and less expensive foundations.
- ▶ Strong and flexible – qualities that hold the structure together while helping it spring back into place after an earthquake.
- ▶ Long term effectiveness is assured – any damaged sections or beams can be repaired or replaced with relative ease.
- ▶ Meeting changing needs – beams and columns can be coupled and uncoupled for alterations, or dismantled altogether for use in another construction project.

One such innovative new building – at Massey University's College of Creative Arts in Wellington – uses the Pres-Lam solution. It will provide flexible studio teaching space as well as classrooms and a workshop, green-screen film studio, gallery and multipurpose presentation space. Its lower levels align with the site contours, while the upper three levels are supported by a lightweight, naturally ventilated LVL structure comprising 15 columns and 16 beams, braced by three concrete shear walls. All structural components have been prefabricated off-site. Project Manager Matt Mumford reports that BBR Contech's role was to post-tension the columns and beams using tendons



comprising six 12.7 mm strands with capacities of 1,100 kN. The beam and column tendons are anchored using single strand barrel and wedge to large plates at each end. The concrete shear wall tendons comprise 1905 anchorages with a capacity of 3,500 kN. Unlike the approach used in PRESSSS, the strands in the beams and columns are greased and sheathed and fully unbonded, whereas the shear wall tendons have partial bonding close to the anchorages. This is a highly viable solution that could be the key to ensuring that buildings – and lives – are saved should the unthinkable ever happen again.

TEAM & TECHNOLOGY

OWNER Massey University
MANAGEMENT CONTRACTOR Arrow International
ARCHITECT Ian Athfield Architects
DESIGNER Dunning Thornton Consultants
TECHNOLOGY BBR CONA internal
BBR CONA unbonded
BBR NETWORK MEMBER
BBR Contech (New Zealand)



Demolition underway of the car park of the Hotel Grand Chancellor – giving an insight into the scale of work necessary.

Some, such as the CBD's Forsyth Barr Tower and Clarendon Tower; may need a double-dose of repairs. After both were damaged in the September earthquake, our team undertook crack injection work, injecting epoxy resin, into cracks in floor topping slabs, concrete gravity beams and car park columns and beams.

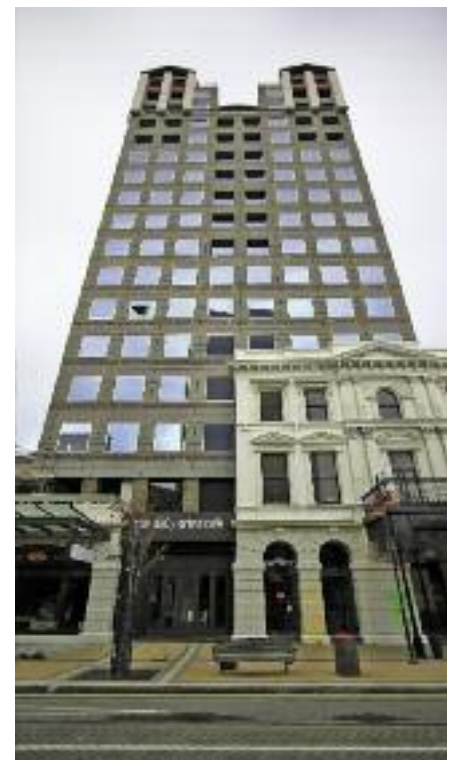

Clarendon Tower in the Christchurch CBD, despite repair work following the first quake, may now need demolition.

Two shopping malls – The Palms to the north-east of Christchurch city and Eastgate Mall in the east – have had their own share of trials and tribulations. After the February earthquake, we carried out concrete repairs to the tops and bottoms of a large number of concrete columns in The Palms retail centre and adjacent multi-level car parks. This work included forming and pouring with fine aggregate concrete and structural mortar before confining the columns with carbon fibre wrap. Further work was required after the June 2011 shake and The Palms was re-opened in September; while Eastgate opened again in July.



BBR Contech carried out concrete repairs at The Palms retail centre after the February earthquake.

We have also worked on some important community infrastructure repairs on hospital buildings owned by the Canterbury District Health Board. The older buildings of Christchurch Public and Princess Margaret hospitals suffered damage to concrete floors and walls requiring extensive epoxy injection of cracking. The liquefaction added stress to basement regions causing ingress of water and silt. A significant amount of waterproofing has been carried out with injection of polyurethane grouts to stem the flows entering into important service areas. The enormity of earthquake forces can be observed in some areas where thick concrete raft foundations have been pressed upwards by hydraulic forces from underneath – causing localised cracking and separation of construction joints.

Learning lessons and sharing initiatives

John Hare is a Director of Holmes Consulting Group and has a long association with seismic upgrading. He is President of the Structural Engineering Society New Zealand and currently also a principal engineering advisor for the Canterbury Earthquake Recovery Authority (CERA).

Holmes Consulting and BBR Contech have worked together on many projects, both before and after the earthquakes. John now shares with Paul Wymer, BBR Contech CEO, some of the lessons learnt in terms of the performance of buildings and some initiatives towards providing greater earthquake safety for buildings.

The learning process is still evolving but some key observations and considerations for the future, so far are:

- ▶ Modern buildings on good foundations, constructed in accordance with the building code in force now protected lives, even when exposed to greater shaking than the code design level.
- ▶ Ongoing research and development and the eventual use of the resulting improved technology will help to further reduce damage in larger earthquakes.
- ▶ The seismic design levels for existing buildings imposed by central and local government are likely to be increased to better protect occupants and to provide greater resilience. For new buildings, the existing load levels may be adequate for life safety protection, but if owners desire better performance, higher load levels and increased detailing for resilience may be needed.
- ▶ Configure structures, so that they are as symmetrical as possible, to minimize eccentric loads imposed on some elements.



- ▶ A greater emphasis is required on quality control and inspections during construction to ensure that the intended methods of construction are achieved.
- ▶ Insurance and reinsurance considerations are likely to drive a greater level of attention to seismic resistance. Older buildings and those that are deemed earthquake-prone may become uninsurable or could be subject to special exclusions and high premiums. Many of these lessons and initiatives to provide greater earthquake safety will inevitably result in extra costs for building owners and tenants. The question of how these costs balance out against the risk appetite for the general public and Government imposed design levels remains to be seen. However, with the Christchurch rebuild expected to cost in the order of NZ\$15 billion, there will be a strong business case to support consideration of some additional cost at the time of construction or retrofitting. And included in this business case will surely be a very close analysis of the insurance position.

In contrast, the new Christchurch Women's Hospital opened in 2005 is the first building



in the South Island to use base isolation technology and it performed exactly as intended. This 10 storey state-of-the-art building has more than 20,000 m² of floor area and was designed to withstand Christchurch's largest predictable earthquake. The building foundation includes five unbonded multi-strand tie-down tendons anchored beneath the raft foundation – three with BBR CONA 4205 and two with BBR CONA 1205. These anchors work in tandem with the base isolation bearings to provide the restraining force against uplift during a seismic event →



Strengthening work carried out earlier by BBR Contech contributed to the resilience of Christchurch Arts Centre's Old Arts School.

BBR projects – how did they fare?

While nearly every building in the Christchurch Arts Centre complex is in need of extensive repair, the Old Arts School remains largely untouched. The FRP strengthening work we under-took in 2008 contributed to this resilience. But the Great Hall was not so lucky – after the June 2011 earthquake, we were engaged in a project to hold it together until a permanent repair solution can be found. This work involved using five cranes to install strand and bar tendons through temporary structural steel frames at gable wall ends.



Strand and bar tendons installed through temporary structural steel frames at gable wall ends must hold the Great Hall together until a permanent repair solution can be found.



Just five days before the September earthquake, BBR completed the strengthening of 23 circular columns at the University of Canterbury's Student Services Building.

Another, more recent, FRP strengthening project has also delivered results. Just five days before the September earthquake, we completed strengthening 23 circular columns at the University of Canterbury's Student Services Building. This involved applying two layers of glass fibre wrap in the top and bottom 600 mm of the columns. Our post-earthquake inspection revealed that the columns remained intact and new cracks had appeared behind the glass fibre where the additional confinement had resisted the earthquake loading – exactly as intended.

SUPPORTING RESEARCH
Given its involvement in these and many more earthquake-related projects, we are delighted to be participating in a six-year University of Canterbury earthquake engineering research study with the theme of 'Retrofit Solutions for New Zealand Multi-Storey Buildings'. The research team has built a three-storey pre-1970s reinforced

concrete model building – to 40% scale – and has been testing it on the 'shake table' at the University's Structures Laboratory. They are investigating the structural dynamics of the building before and after a rehabilitation or retrofit intervention, with the aim of upgrading its performance when subject to the ground movements produced by earthquakes. The team has recently studied the response of the building due to ground motions recorded in the September 2010 Christchurch earthquake and



Chile's 8.8 magnitude earthquake in February 2010. The next steps involve observing its response to the same conditions when we have repaired and rehabilitated it with GFRP (glass-fibre-reinforced polymer) – a solution that is neither invasive, nor expensive. In the light of what has been happening in Christchurch, there will be much attention focused on the outcome.

A LONG-TERM OUTLOOK

The Canterbury rebuilding programme has just begun. We have provided estimates for a large number of projects – with approvals subject to the resolution of insurance issues and land designations.

The continuing aftershocks mean that nothing is certain. While a number of CBD buildings investigated for repair have since been demolished, about 1,200 others remain standing awaiting decisions on their fate – and may eventually be deemed economic to repair. Whatever the outcome, the nature of the reconstruction will change the face of Christchurch and BBR Contech stands ready to help – with repair and strengthening or new build technology – and always with an eye to protecting, preserving and future-proofing Christchurch's built environment for many years to come. ●



SEMEDELA OVERPASS, KOPER, SLOVENIA

Complex reconstruction



MRR

An existing overpass has been rebuilt during the construction of the new H5 Koper to Izola Expressway in Slovenia. Kresimir Bogadi of **BBR Adria** presents a brief insight into the project.

Originally built in 1981, the overpass had three traffic lanes, plus two pedestrian walkways, on its 15.2 m structure. Reconstruction was completed in two phases. The first was between axis OI and axis 7, where the superstructure was widened and the second, between axis 7 and axis OD, where it was necessary to demolish the superstructure and build a new one. In the new layout, the overpass lies between two circular junctions, with the Semedela junction sitting partially on the structure. The new traffic solution requires four 3.25 m wide traffic lanes. As there is a pedestrian underpass near the structure, it was decided that a pedestrian lane was not necessary. This made it possible to meet new traffic requirements with strengthening and minimal widening of the superstructure between axis OI and axis 7.

For the second phase, there was 1.2 m height difference between the old and

new structure and this part of the overpass also widens in a funnel shape. The latter was the reason for deciding to demolish the old superstructure and build a new one. The superstructure was executed as a continuous slab with cantilevers on both sides and longitudinal post-tensioning with 51 BBRVT CONA CMI 1506 tendons. While the width of the structure varies, its thickness of 1.05 m is constant. Lack of access meant that tendons had to be stressed from one side to a force of 2,900 kN each – resulting in a total force of almost 150 MN. ●

TEAM & TECHNOLOGY

- OWNER** DARS d.d.
- MAIN CONTRACTOR** Kraski Zidar d.o.o.
- DESIGNER** GRADIS Biro Za Projektiranje Maribor d.o.o.
- TECHNOLOGY** BBR VT CONA CMI internal
- BBR NETWORK MEMBER** BBR Adria d.o.o. (Croatia)



Repairs for the rugby

QUEENS WHARF, AUCKLAND, NEW ZEALAND

Between 9 September and 23 October 2011, New Zealand became the centre of the rugby universe, with 20 teams vying for the title of Rugby World Cup champion. In preparation for this huge international event, Auckland's waterfront area – designated 'Party Central' – underwent some redevelopment to deal with the large influx of fans and **BBR Contech** was associated with a number of projects. **BBR Contech's** Northern Regional Manager, Keith Snow and Project Manager, Mark Kurtovich outline the work associated with the repair and strengthening of Queens Wharf in preparation for the event.

Having already completed a major wharf repair project at Auckland's Downtown Ferry Terminal, BBR Contech was familiar with the waterfront environment. So the company was pleased to take on the task of repairing the substructure of Queens Wharf – one project among many to prepare it for its role as the venue for Rugby World Cup 2011's 'Fanzone, Festival and Showcase' events. Thousands descended on the wharf to watch the games on big screens, enjoy free concerts by top Kiwi bands and experience displays of New Zealand's creativity, innovation and ingenuity. Key attractions included 'The Cloud', a purpose-built structure capable of holding more than 6,000 people; the 'ANZ Dome', which offered a host of interactive experiences; and the Giant Rugby Ball, which provided an audio-visual experience of New Zealand and its landscape, culture and tourism attractions.

Built of reinforced concrete and completed in 1913, Queens Wharf is an important part of Auckland's social, industrial and engineering heritage. It is the second oldest wharf structure left on the waterfront – and originally developed as a key hub for New Zealand's burgeoning import and export industries. One hundred years after it was built, the wharf was naturally exhibiting signs of deterioration. BBR Contech's job was to make it structurally sound by removing and reinstating 185 m³ of concrete and replacing much of the reinforcing bar – essentially two-thirds of the wharf's substructure. The defective concrete was removed using 'hydro-demolition', applying high-pressure water to deliver an excellent bonding surface for repairs while minimising noise in the inner city environment. The work was completed four weeks ahead of schedule, the team having

overcome all the challenges of working with the tides, managing the risks of operating in such a public location, dovetailing the work schedule with other projects happening on the wharf, and ensuring all the debris was disposed of responsibly. BBR Contech also completed a separate contract, undertaking repairs to the wharf deck while ensuring that historic features such as old railway lines were preserved and restored.

The client was delighted with the results.

"What impressed me most was the consistency with which BBR Contech performed," says Mark Fraser, Project Leader Queens Wharf for Waterfront Auckland. "The team delivered exactly as they said they would, but ahead of time and with a larger scope than we originally set out to achieve, all the while working around and with two other contractors on site. Delivering possibly the highest-volume repair project in New Zealand and in such a short timeframe made for a very impressive performance."



Speaking of impressive performances, the New Zealand All Blacks completed the tournament unbeaten and went on to meet France in the final on 23rd October 2011 – and winning in a very close and exciting match. After winning the inaugural World Cup competition in 1987, the All Blacks had endured a long wait before they could again hold the William Webb Ellis Trophy aloft to crown them as 2011 Rugby World Champions, much to the relief of the whole nation – the so-called 'stadium of four million people'. ●

TEAM & TECHNOLOGY

OWNER Waterfront Auckland

MAIN CONTRACTOR BBR Contech

DESIGNER Beca Infrastructure

TECHNOLOGY MRR range

BBR NETWORK MEMBER
BBR Contech (New Zealand)

INFRASTRUCTURE FOR ENERGY

Electrifying performance

Supplying the demands of energy hungry populations is a constant battle for governments, scientists and businesses. Increasingly environmentally-friendly – or ‘sustainable’ – solutions are required from the construction industry, while the practicalities and associated costs must be weighed by infrastructure owners. With all these factors in mind, there are some compelling advantages for choosing BBR technology. We examine three sectors – hydroelectric, nuclear and wind energy – where the expertise of the BBR Network has made a significant and sustained contribution. →

Lean, green yet strong



As long as the human race inhabits this planet, it will need energy to survive. The challenge now is for us to be able to satisfy our energy needs in a sustainable and economically viable way. Use of post-tensioning promotes a sustainable approach and reduces concrete volumes used, thus delivers a lower carbon footprint. The BBR VT CONA CMX range is particularly lightweight, very compact and further reduces cross-sectional areas of concrete structures due to the small centre spacing requirement between anchorages. In addition, recycled concrete can be used effectively with CONA CMX post-tensioning as the tendons can be stressed at comparatively low concrete strengths.

The constant development of BBR technology, driven by customers through contact with the BBR Network, means that we can supply lean yet strong solutions for all types of structure. Our solutions are lean because you only use the amount of material you actually need while achieving the same structural strength. In essence, with our CONA CMX technology, we have engineered out the surplus. As you will have seen, in *Consuming passion for LNG* on pages 49-53, the use of BBR post-tensioning for LNG tank construction offers a saving in both time and materials, while creating energy infrastructure that is eminently maintainable. Now, we look at three further types of energy installation where BBR technology and know-how plays a crucial role.

HYDROELECTRICITY

Harnessing hydro power

Dams are unique among structures because of their huge size and the massive amount of water or other liquids they retain – and the vast scale of human, ecological and economic losses their failure would bring. They are expected to age and deteriorate over time due to geological and chemical factors, thus programs of surveillance and maintenance – using continually advancing technology – are implemented to ensure their continued safe operation.

BBR ground anchoring technology has been used in dam construction and strengthening projects for over 60 years. The first BBR prestressed ground anchors were used in 1951 to anchor the walls of the underground machine room for the Maggia Hydroelectric Power Station in Verbano, Switzerland. The following projects are milestones in the evolution in the use of BBR technology and techniques on the international scene for dam strengthening and stabilization and represent just a small number of such projects carried out by the BBR Network.

STABILIZING INTAKE

In the early 1960s, BBRV rock anchors were used to stabilize intake sections of the Wanapum Dam in Washington State, USA, allowing for later construction of the power house substructure. Thirteen anchors were placed in each intake and holes were drilled to a maximum of 80 ft into the rock foundation. After structural concrete had been placed and attained the required strength, the anchor assemblies were lowered into the drilled holes and the bottom 30 ft grouted.





MAJOR REHABILITATION

After rains, brought by Hurricane Agnes in 1972, raised the water in the reservoir to 2.5 ft above its normal level, the decision was taken to upgrade the 50-year old Conowingo Dam in Maryland, USA. This initiated what was then thought to be the biggest dam rehabilitation project using post-tensioned anchorages in the world. The project involved drilling through some 200 ft of concrete and bedrock to install 1,100 t of prestressing steel in the form of 537 BBRV rock anchors. Today, the dam provides feedwater for hydroelectric power generation, cooling water for a nuclear power station and water for public supply.

GROWING STABILITY

In 1985, Australia's Chichester Dam, on the Hunter River, was fitted with BBRV rock anchors to increase its stability and height. The anchors, weighing up to three tons each, were installed using a special device – running on the crest of the dam – which was equipped with pulling and breaking winches. The anchors were required to have double corrosion protection, facilities for force monitoring at any time and to be restressable during the lifespan of the dam.

UPGRADING & SECURING

The upgrading project in the early 1990s at Waitakere Dam, near Auckland, New Zealand, featured the

installation of 55 vertical BBR CONA rock anchors with lengths of up to 60 m. The anchors have the facility for continuous load monitoring and restressing. 260 BBRV tendons pass through the dam to stress together the sections of the original 1910 dam and the dam extension built in 1928. Two BBRV tendons were provided for each vertical rock anchor to resist bursting stresses.



WORLD RECORD CAPACITY ANCHORS

The existing ground anchors at Catagunya Dam had reached the end of their service life and were replaced using 92 BBRVT CONA CMG tendons but, with reduced availability of anchor locations, even higher capacity was sought. This led to the adoption of 91-strand tendons using 15.7 mm diameter strand – and setting new world records for permanent ground anchors, with an MBL of 25,389 kN, test load of 19,415 kN (1,980 t) and lock-off load of 17,772 kN (1,812 t). Since this project was completed in 2010, similar ultra high capacity anchors have also been installed at Wellington Dam in Western Australia, see pages 76 and 77.





three at Forsmark – and all feature BBR technology. Today, nearly 50% of Sweden's electrical energy is produced by nuclear power plants.

Ringhals, on the west coast some 60 km south of Gothenburg, is the largest power plant in Scandinavia. It has four reactors – number 1 is a boiling water reactor and numbers 2, 3 and 4 are pressurized water reactors. In a normal year, Ringhals generates some 28 billion kilowatt hours of electricity – about one fifth of Sweden's total electrical energy consumption.

The Swedish government decided not to shut down the Ringhals plant as originally planned, but to upgrade it instead. Now, discussions are underway about replacing the old reactors when the time comes, rather than building new ones.



NUCLEAR POWER

Realizing longevity & safety

BBR has over 60 years' experience in the design and application of post-tensioning products. Within the nuclear industry, the focus of the BBR Network is on safety and maintenance to extend the safe operating life of existing plants. Our leading edge technology and know-how has been applied to 65 nuclear facilities in many countries.



Nuclear reactors have a nominal design life of around 30 years, however, this may be extended by further investment in reactor maintenance upgrades. The Ringhals Nuclear Power Station, in Sweden, is one plant where such investment is currently underway, with the help of the BBR Network.

THE RINGHALS STORY

Sweden has a total of ten nuclear reactors – four at Ringhals, three at Oskarshamn and

NUCLEAR REACTOR UPGRADING

Tommy Lindstrand of Swedish BBR Network Member **Spännteknik AB** explains that Ringhals 1 is prestressed with 55 6 mm diameter, cement-grouted BBRV tendons, while Ringhals 2, 3, and 4 are pre-stressed with 139 6 mm diameter BBRV tendons and grouted with a grease/petrolate type nuclear grade casing filler.

The upgrading of Ringhals 4 included replacing three steam generators and one condenser to increase safety and secure future electricity production. We had carried



out very similar work on an earlier occasion for both Ringhals 2 and 3.

TRANSFER OPENING

The work required a transfer opening in the secondary containment wall of 6 m by 8 m. The 1,200 mm thick wall has a 20 mm steel lining at approximately 1,000 mm from the outer surface.

A steam generator is about 21 m long and weighs nearly 334 t. Lifting operations, performed on the outside, were assisted by a 660 t crane. A slide way was installed in the opening to allow removal of the old equipment and insertion of the new kit into the reactor building.

BALANCING CONTAINMENT

Our job was to remove the tendons crossing the required opening – and, to keep the containment in balance, we de-stressed many other tendons too.

Our scope of work included:

- ▶ Training program in 2010 – connecting and testing of ducts in the opening
- ▶ Training program in 2011 – de-stressing and stressing of tendons
- ▶ De-stressing, removal, storage, installation and stressing of nine vertical and 20 horizontal tendons

- ▶ De-stressing and stressing of 56 horizontal tendons
- ▶ Grease grouting of 85 tendons
- ▶ Delivery, installation and testing of smooth ducts for tendons in the opening
- ▶ Tent, including dehumidification, for storage of tendons
- ▶ Work planning and documentation
- ▶ Necessary courses and medical examination
- ▶ Accommodation for our personnel



At times, we had to work around-the-clock and this required a team of 24 people. With the grouting of the last tendons on 20 September 2011, our work here on this major project was finished. All documents are now approved – and both the client and indeed our own team are very satisfied with the job which was performed exactly according to the plan.

TEAM & TECHNOLOGY

- OWNER Vattenfall
- MAIN CONTRACTOR AREVA NP GmbH
- LIFTING & CONCRETING SUBCONTRACTOR NCC
- TECHNOLOGY BBRV wire
- BBR NETWORK MEMBER Spännteknik AB (Sweden)

Chasing the wind



Despite tough economic conditions, global wind power capacity rose to 197 GW – a 24.1% increase over the previous year. The outlook for 2011 is more optimistic, with overall investment predicted to reach €70.4 billion (US\$96 billion) – and likely to translate into actual projects during the next two years.

A total of 84,074 MW is now installed in the European Union, a growth of 12.2% on the previous year. Germany remains the EU country with the largest installed capacity, followed by Spain, France, the UK and Italy. The European offshore wind power market experienced a massive increase of 51% during 2010.

Since the end of the 1990s, the BBR Network has been involved in both research and development, as well as the construction of wind towers – often in harsh, inhospitable environments. So far, BBR Network Members have been contracted for over 12 wind park projects and prototypes.

WIND TOWER CONSTRUCTION

Basically, three types of construction are common for the wind towers – steel, concrete and a hybrid mixed version. Currently, the hybrid construction method seems to be the most economical for high

towers which require thicker walls and tower diameters in the foot. Post-tensioned concrete plays an important role in realizing the full potential of wind energy. Concrete tower solutions are adaptable and durable



and offer long life performance with minimum maintenance. The use of precast or in-situ PT concrete, rather than steel, in the construction of windfarms offers several advantages to owners and operators:

- ▶ Reduced maintenance costs and long-life performance – through comparative durability of concrete over steel.
- ▶ Up to 15% higher energy production – PT concrete pylons can be 30-40 m higher.
- ▶ Lower transportation costs – casting is not highly specialized and can be carried out near the site.
- ▶ Design and construction flexibility – versatility of concrete enables design solutions with no restrictions on height or size.
- ▶ Dynamic performance – PT concrete has inherently high damping properties and can deliver fatigue resistance solutions with less noise emissions.

Taller wind towers need greater structural strength and stiffness to carry both the increased turbine weight and bending forces from wind action on the rotors and the tower and also to avoid damaging resonance.



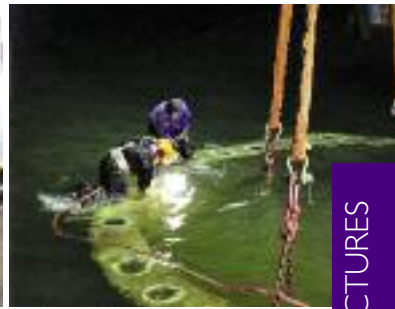

Key issues are the minimization of material content and structural weight and reduction of construction time. In-situ slipform construction overcomes the problems of transporting large tower rings/sections and need for large cranes for erection.

The ability to prestress concrete means that individual wind tower structures can be tailored to provide optimal levels of stiffness and dynamic performance using post-tensioned tendons.

Ducts can be incorporated into both precast concrete units and in-situ concrete – either located within pylon walls or externally on the inner wall of the pylon structure. This facilitates thin, lightweight wall construction with simple access for inspection and future capacity upgrades. A combination of internal and external tendons can be considered whereby, for instance, external tendons stabilize the tower from the base up to a defined stage and are anchored in a corbel. Internal tendons are stressed at full height from the top corbel to the base segment. The move towards taller wind towers is tipping the balance towards PT concrete design solutions with their many advantages. BBRVT CONA CMX products – ground anchors, band systems, internal and external post-tensioning – are well-suited to the construction of precast elements or in-situ concrete method used for windfarms. With the know-how of BBR Network Members, concrete pylons could reach heights of over 120 m!

TESTING TIMES

Recently, **Vorspann-Technik** – the German BBR Network Member – constructed two 130 m high prototype wind towers using



CONA CMB tendons at a test field in Bremerhaven. Meanwhile in Hamburg, they built a further two towers using CONA CMB technology – these towers are approaching 140 m high and have rotors covering an area larger than a football pitch!



CHILLY ARCTIC WINDS

The team from BBR Network Member, **KB Spenneteknik** in Norway, faced an arctic climate and persistently strong winds to provide foundations for 17 windmills for their client Statkraft. The Kjøllefjord Wind Project is located 74° North, on Mount Gartefjell – 230-300 m above sea level – in the municipality of Lebesby in Finnmark, Norway. Foundations for the windmills consisted of 136 CONA Multi 1906 rock anchors – eight anchors per windmill. The

expected average annual output of the wind farm – which opened in October 2006 – is in the region of 150 GWh, equal to the consumption of around 7,500 households.

STORMY WATERS

A wind farm has been built in Lake Vänern – covering an area of 5,655 km², it is the third largest lake in Europe. **Spännteknik**, the BBR Network Member in Sweden played a key role in delivering the Vindpark Vänern wind energy project. The round six meter diameter foundations had been prefabricated in one meter high sections with recesses for the tendons. Each foundation was anchored by 16 BBR CONA 1906 rock anchors – with a length of 25-28 m, depending on the water depth and with the help of divers.

TECHNOLOGY FOR THE FUTURE

As well as awesome dam structures, timely nuclear power services and breathtaking wind energy projects, BBR ground anchors have also been applied, as reported in *CONNAECT 2008*, to strengthen bases of electricity transmission tower bases in New Zealand's South Island. It is clear that the BBR Network has both the technology and the expertise to support the many and diverse needs of the energy sector well into the future!



HEADQUARTERS

SWITZERLAND

BBR VT International Ltd
Bahnstrasse 23
8603 Schwerzenbach (ZH)
Tel +41 44 806 80 60
Fax +41 44 806 80 50
www.bbrnetwork.com
info@bbrnetwork.com

Additional BBR technology licenses have been granted in Europe, Asia Pacific and America – for more information, please contact the BBR Headquarters.

AMERICAS



EASTERN CANADA

Canadian bbr Inc.
3450 Midland Ave.
Scarborough
Ontario M1V 4V4
Tel +1 416 291 1618
Fax +1 416 291 9960
mducommun@bbrcanada.com

EUROPE

AUSTRIA

KB Vorspann-Technik GmbH
Weitwörth 25
5151 Nussdorf a.H.
Tel +43 6272 40790
Fax +43 6272 4079040
www.kb-vt.com
office@kb-vt.com

GERMANY

KB Vorspann-Technik GmbH
Fürstenrieder Strasse 275
81377 München
Tel +49 89 72 44 969-0
Fax +49 89 72 44 969-12
www.kb-vt.com
office@kb-vt.com

BELGIUM

see Netherlands

HUNGARY

see Austria

BOSNIA/ HERZEGOVINA

see Croatia

IRELAND

see United Kingdom

BULGARIA

see Spain

LATVIA

see Austria

CROATIA

BBR Adria d.o.o.
Kalinovica 3
10000 Zagreb
Tel +385 1 3839 220
Fax +385 1 3839 243
www.bbr-adria.com
bbr-adria@bbr-adria.com

LITHUANIA

see Austria

MONTENEGRO

see Croatia

CZECH REPUBLIC

see Austria

DENMARK

see Norway

ESTONIA

see Austria

FINLAND

see Norway

FRANCE

ETIC S.A.
48, rue Albert Joly
78 000 Versailles
Tel +33 1 39 50 11 20
Fax +33 1 39 50 11 03
www.etic-sas.fr
contact@etic-sas.fr

NETHERLANDS

Spanstaal B.V.
Koningsweg 28
3762 EC Soest
Post Address:
PO Box 386
3760 AJ Soest
Tel +31 35 603 80 50
Fax +31 35 603 29 02
www.spanstaal.nl
info@spanstaal.nl

 **NORWAY**

KB Spenneteknikk AS
 Siva Industrial Estate
 N. Strandsveg 19-21
 Postboks 1213
 2206 Kongsvinger
 Tel +47 62 81 00 30
 Fax +47 62 81 00 55
www.spennteknikk.no
spennteknikk@spennteknikk.no

 **POLAND**

(Head Office)
BBR Polska Sp. z o.o.
 ul. Annopol 14
 03-236 Warszawa
 Tel +48 22 811 50 53
 Fax +48 22 811 50 53 55
www.bbr.pl
bbrpolska@bbr.pl

BBR Polska Sp. z o.o.
 ul. Tamogorska 214a
 44-105 Gliwice
 Tel +48 32 331 47 98
 Fax +48 32 330 24 11
www.bbr.pl
bbrpolska.gliwice@bbr.pl

 **PORTUGAL**

see Spain

 **ROMANIA**

see Spain

 **RUSSIA**

see Austria

 **SERBIA**

see Croatia

 **SLOVAKIA**

see Austria

 **SLOVENIA**

see Croatia

 **SPAIN**

**BBR Pretensados
 y Técnicas Especiales, S.L.**
 Antigua Carretera N-III
 Km. 31, 150
 28500 Arganda del Rey, Madrid
 Tel +34 91 876 09 00
 Fax +34 91 876 09 01
www.bbrpte.com
bbrpte@bbrpte.com

 **SWEDEN**

Spännteknik AB
 Sjöängsvägen 7
 192 72 Sollentuna
 Tel +46 8 510 678 10
 Fax +46 8 510 678 19
www.spannteknik.se
info@spannteknik.se

 **UKRAINE**

see Poland

 **UNITED KINGDOM**

Structural Systems (UK) Ltd
 12 Collett Way
 Great Western Industrial Estate
 Southall
 Middlesex
 UB2 4SE
 Tel +44 20 8843 6500
 Fax +44 20 8843 6509
www.structuralsystemsuk.com
info@structuralsystemsuk.com

MIDDLE EAST

BAHRAIN

see United Arab Emirates

IRAQ

Specialized Prestressing Co
Karrada, Dist. 901, St. 1, Bldg. 16
Office No. 10
Baghdad
Tel +964 79 016 612 56
www.spc-iraq.com
office@spc-iraq.com

JORDAN

**Marwan Alkurdi & Partners
Co. Ltd**
PO Box 506
Amman 11821
Tel +962 6 581 9489
Fax +962 6 581 9488
www.mkurdi.com
ali@mkurdi.com

OMAN

see United Arab Emirates

QATAR

see United Arab Emirates

KINGDOM OF SAUDI ARABIA

Huta-Hegerfeld Saudia Ltd
BBR Prestressing Division
Prince Sultan St. Lotus Building
PO Box 1830
Jeddah
Tel +966 2 662 3205
Fax +966 2 683 1838
www.hutahegerfeld.com.sa
bbr@huta.com.sa

SYRIA

see Jordan

AFRICA

SOUTH AFRICA

Structural Systems (Africa)
Block B, 60 Civin Drive
Pellmeadow Office Park
Bedfordview, Johannesburg 2007
Tel +27 11 409 6700
Fax +27 86 616 7482
www.structuralsystemsafrika.com
info@sslafrica.com

ASIA PACIFIC

UNITED ARAB EMIRATES

**NASA Structural Systems LLC
(Head Office)**
Office 603
PO Box 28987
Dubai
Tel +971 4 2948 974
Fax +971 4 2948 984
www.bbrstructuralsystems.com
bbr@bbrstructuralsystems.com

Structural Systems Middle East LLC

Office M-01, Mezzanine Floor
Building Ref C-57
Al Muroor Road
PO Box 126740
Abu Dhabi
Tel +971 2 6438 220
Fax +971 2 6438 221
www.bbrstructuralsystems.com
bbr@bbrstructuralsystems.com

Emirates & Australia Const. Systems LLC

Office 112
Hatem Kamal Farah Building
Beirut Street
PO Box 62174
Sharjah
Tel +971 6 5437 490
Fax +971 6 5437 491
www.bbrstructuralsystems.com
bbr@bbrstructuralsystems.com

INDIA

BBR (India) Pvt Ltd
No. 318, 15th Cross,
6th Main
Sadashivanagar
Bangalore – 560 080
Tel +91 80 4025 0000
Fax +91 80 4025 0001

JAPAN

Japan BBR Bureau
c/o P.S. Mitsubishi Construction
Co. Ltd
Harumi Center Bldg. 3F
2-5-24 Chuo-ku
Tokyo
Tel +81 3 6385 8021
Fax +81 3 3536 6937
mail-01@bbr:gr.jp

MALAYSIA

**BBR Construction Systems (M)
Sdn Bhd**
No. 17, Jalan PJS 11/2
Subang Indah
Bandar Sunway
46150 Subang Jaya
Selangor Darul Ehsan
Tel +60 3 5636 3270
Fax +60 3 5636 3285
www.bbr.com.my
enquiry@bbr.com.my

 **PHILIPPINES**

BBR Philippines Corporation
Suite 502, 7 East Capitol Building
No.7 East Capitol Drive
Barangay Kapitolyo
Pasig City
Metro Manila 1603
Tel +632 638 7261
Fax +632 638 7260
bbr_phils@smartbro.net

 **SINGAPORE**

**BBR Construction Systems
Pte Ltd**
BBR Building
50 Changi South Street 1
Singapore 486126
Republic of Singapore
Tel +65 6546 2280
Fax +65 6546 2268
www.bbr.com.sg
enquiry@bbr.com.sg

 **THAILAND**

Siam-BBR Co Ltd
942/137.1 5th Floor
Charn Issara Tower
Rama 4 Road
Kwaeng Suriwongse, Bangrak
10500 Bangkok
Tel +66 2 237 6164-6
Fax +66 2 237 6167
www.bbr.com.sg
enquiry@bbr.com.sg

 **VIETNAM**

see Singapore

 **AUSTRALIA**

**Structural Systems (Northern)
Pty Ltd**
20 Hilly Street
Mortlake
New South Wales 2137
Tel +61 2 8767 6200
Fax +61 2 8767 6299
www.structuralsystems.com.au
info@nsw.structural.com.au

**Structural Systems (Northern)
Pty Ltd**
Unit 1/12 Commerce Circuit
Yatala
Queensland 4207
Tel +61 7 3442 3500
Fax +61 7 3442 3555
www.structuralsystems.com.au
info@qld.structural.com.au

**Structural Systems (Southern)
Pty Ltd**
PO Box 1303
112 Munro Street
South Melbourne
Victoria 3205
Tel +61 3 9296 8100
Fax +61 3 9646 7133
www.structuralsystems.com.au
info@structural.com.au

**Structural Systems (Western)
Pty Ltd**
PO Box 4050
Victoria Park
Western Australia 6979
3 Craig St
Burswood
Western Australia 6100
Tel +61 8 9267 5400
Fax +61 8 9267 5499
www.structuralsystems.com.au
structural@wa.structural.com.au

 **FIJI**

see New Zealand

 **NEW ZEALAND**

BBR Contech
6 Neil Park Drive, East Tamaki
PO Box 51-391
Pakuranga
Auckland 2140
Tel +64 9 274 9259
Fax +64 9 274 5258
www.contech.co.nz
akl@contech.co.nz

BBR Contech
38 Waione Street, Petone
PO Box 30-854
Lower Hutt
Wellington 5040

Tel +64 4 569 1167
Fax +64 4 569 4269
www.contech.co.nz
wgn@contech.co.nz

BBR Contech
7A Birmingham Drive
Middleton
PO Box 8939
Riccarton
Christchurch 8440
Tel +64 3 339 0426
Fax +64 3 339 0526
www.contech.co.nz
chc@contech.co.nz

